

# OPA168x

## SoundPlus 36-V, Single-Supply, 10-MHz, Rail-to-Rail Output Operational Amplifiers

### 1 Features

- THD+N, 50 mW, 32 Ω, 1 kHz, –109 dB
- Wide Supply Range:
  - 4.5 V to 36 V, ±2.25 V to ±18 V
- Low Offset Voltage: ±0.25 mV
- Low Offset Drift: ±0.5 μV/°C
- Gain Bandwidth: 10 MHz
- Low Input Bias Current: ±10 pA
- Low Quiescent Current: 1.6 mA per Amplifier
- Low Noise: 8 nV/√Hz
- EMI- and RFI-Filtered Inputs
- Input Range Includes Negative Supply
- Input Range Operates to Positive Supply
- Rail-to-Rail Output
- High Common-Mode Rejection: 120 dB
- Industry-Standard Packages:
  - SOIC-8 and SOIC-14
- *micro*Packages:
  - Dual in WSON-8, Quad in VQFN-16

### 2 Applications

- Headphone Driver
- Analog and Digital Mixers
- Audio Effects Processors
- Transducer Amplifiers
- Musical Instruments
- A/V Receivers
- DVD and Blu-Ray™ Players
- Car Audio Systems

### 3 Description

The OPA1688 and OPA1689 are a family of SoundPlus™ 36-V, single-supply, low-noise operational amplifiers capable of operating on supplies ranging from 4.5 V (±2.25 V) to 36 V (±18 V). This latest addition of high-voltage audio operational amplifiers, in conjunction with the OPA16xx devices provide a family of bandwidth, noise, and power options to meet the needs of a wide variety of applications. The OPA168x are available in micropackages, and offer low offset, drift, and quiescent current. These devices also offer wide bandwidth, fast slew rate, and high output current drive capability. The dual and quad versions all have identical specifications for maximum design flexibility.

Unlike most op amps that are specified at only one supply voltage, the OPA168x family is specified from 4.5 V to 36 V. Input signals beyond the supply rails do not cause phase reversal. The input can operate 100 mV below the negative rail and within 2 V of the top rail during normal operation. Note that these devices can operate with full rail-to-rail input 100 mV beyond the top rail, but with reduced performance within 2 V of the top rail.

The OPA168x series of op amps are specified from –40°C to 85°C.

#### Device Information<sup>(1)</sup>

PART NUMBER	PACKAGE	BODY SIZE (NOM)
OPA1688	SOIC (8)	4.90 mm × 3.91 mm
	WSON (8)	3.00 mm × 3.00 mm
OPA1689 <sup>(2)</sup>	SOIC (14)	8.65 mm × 3.91 mm
	VQFN (16)	3.50 mm × 3.50 mm

(1) For all available packages, see the orderable addendum at the end of the datasheet.

(2) Product-preview device.

#### Headphone Amplifier Circuit Configuration

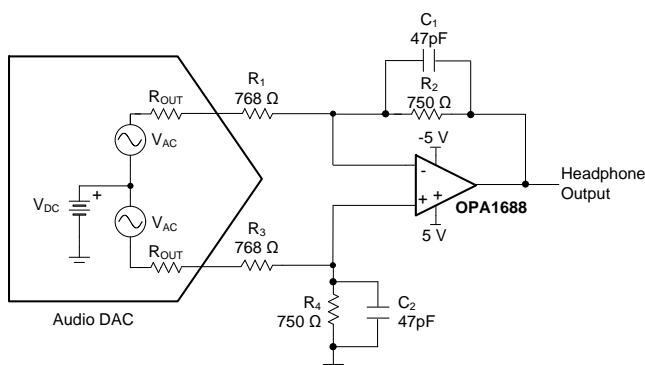

#### Superior THD Performance (f = 1 kHz, BW = 80 kHz, V<sub>S</sub> = ±5 V)

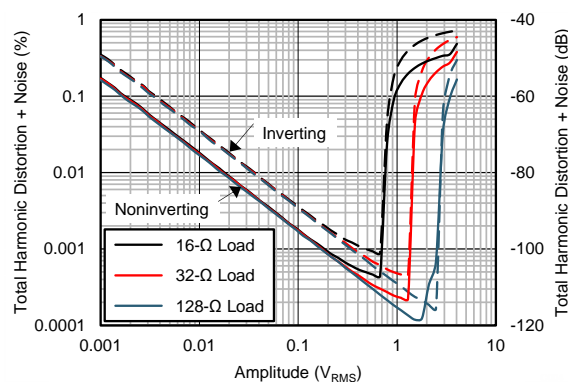

## Table of Contents

<b>1</b>	<b>Features</b> .....	<b>1</b>	9.3	Feature Description .....	<b>19</b>
<b>2</b>	<b>Applications</b> .....	<b>1</b>	9.4	Device Functional Modes.....	<b>21</b>
<b>3</b>	<b>Description</b> .....	<b>1</b>	<b>10</b>	<b>Applications and Implementation</b> .....	<b>24</b>
<b>4</b>	<b>Revision History</b> .....	<b>2</b>	10.1	Application Information.....	<b>24</b>
<b>5</b>	<b>Device Comparison Table</b> .....	<b>3</b>	10.2	Typical Application .....	<b>24</b>
<b>6</b>	<b>Device Family Comparison Table</b> .....	<b>3</b>	<b>11</b>	<b>Power Supply Recommendations</b> .....	<b>28</b>
<b>7</b>	<b>Pin Configuration and Functions</b> .....	<b>3</b>	<b>12</b>	<b>Layout</b> .....	<b>28</b>
<b>8</b>	<b>Specifications</b> .....	<b>5</b>	12.1	Layout Guidelines .....	<b>28</b>
8.1	Absolute Maximum Ratings .....	<b>5</b>	12.2	Layout Example .....	<b>29</b>
8.2	ESD Ratings.....	<b>5</b>	<b>13</b>	<b>Device and Documentation Support</b> .....	<b>30</b>
8.3	Recommended Operating Conditions .....	<b>5</b>	13.1	Device Support.....	<b>30</b>
8.4	Thermal Information: OPA1688 .....	<b>6</b>	13.2	Documentation Support .....	<b>30</b>
8.5	Thermal Information: OPA1689 .....	<b>6</b>	13.3	Related Links .....	<b>30</b>
8.6	Electrical Characteristics.....	<b>7</b>	13.4	Community Resources.....	<b>30</b>
8.7	Typical Characteristics: Table of Graphs .....	<b>9</b>	13.5	Trademarks .....	<b>31</b>
8.8	Typical Characteristics.....	<b>10</b>	13.6	Electrostatic Discharge Caution.....	<b>31</b>
<b>9</b>	<b>Detailed Description</b> .....	<b>18</b>	13.7	Glossary .....	<b>31</b>
9.1	Overview .....	<b>18</b>	<b>14</b>	<b>Mechanical, Packaging, and Orderable Information</b> .....	<b>31</b>
9.2	Functional Block Diagram .....	<b>18</b>			

## 4 Revision History

DATE	REVISION	NOTES
September 2015	*	Initial release.

## 5 Device Comparison Table

DEVICE <sup>(1)</sup>	PACKAGE
OPA1688 (dual)	SOIC-8, WSON-8
OPA1689 (quad)	SOIC-14, VQFN-16

(1) The OPA1688 SOIC-8 and WSON-8 packages are production data. The OPA1689 SOIC-14 and VQFN-16 packages are product preview.

## 6 Device Family Comparison Table

DEVICE	QUIESCENT CURRENT (I <sub>Q</sub> )	GAIN BANDWIDTH PRODUCT (GBP)	VOLTAGE NOISE DENSITY (e <sub>n</sub> )
OPA168x	1650 μA	10 MHz	8 nV/√Hz
OPA165x	2000 μA	18 MHz	4.5 nV/√Hz
OPA166x	1500 μA	22 MHz	3.3 nV/√Hz

## 7 Pin Configuration and Functions

**D Package: OPA1688  
SOIC-8  
Top View**

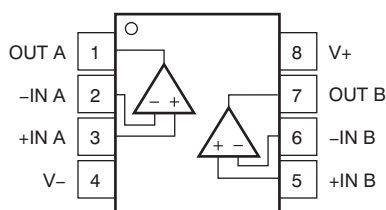

**DRG Package: OPA1688  
WSON-8  
Top View**

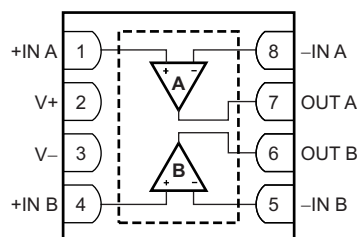

**D Package: OPA1689  
SOIC-14  
Top View**

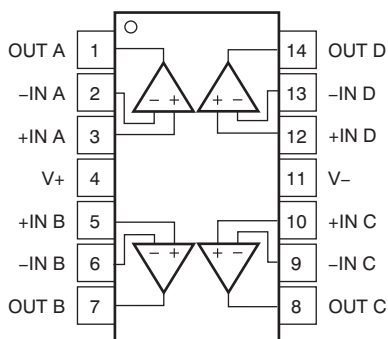

**RVA Package: OPA1689  
VQFN-16  
Top View**

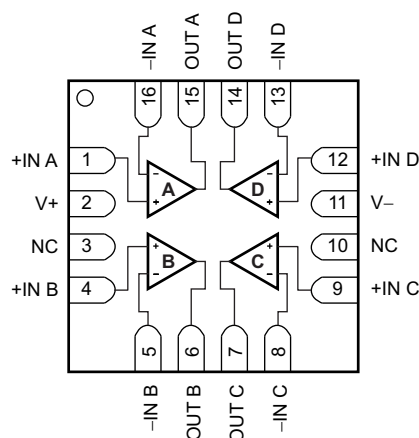

**Pin Functions: OPA1688**

PIN			I/O	DESCRIPTION
NAME	OPA1688			
	D (SOIC)	DRG (WSON)		
+IN A	3	1	I	Noninverting input, channel A
+IN B	5	4	I	Noninverting input, channel B
–IN A	2	8	I	Inverting input, channel A
–IN B	6	5	I	Inverting input, channel B
OUT A	1	7	O	Output, channel A
OUT B	7	6	O	Output, channel B
V+	8	2	—	Positive (highest) power supply
V–	4	3	—	Negative (lowest) power supply

**Pin Functions: OPA1689**

PIN			I/O	DESCRIPTION
NAME	OPA1689			
	D	RVA		
+IN A	3	1	I	Noninverting input, channel A
+IN B	5	4	I	Noninverting input, channel B
+IN C	10	9	I	Noninverting input, channel C
+IN D	12	12	I	Noninverting input, channel D
–IN A	2	16	I	Inverting input, channel A
–IN B	6	5	I	Inverting input, channel B
–IN C	9	8	I	Inverting input, channel C
–IN D	13	13	I	Inverting input, channel D
OUT A	1	15	O	Output, channel A
OUT B	7	6	O	Output, channel B
OUT C	8	7	O	Output, channel C
OUT D	14	14	O	Output, channel D
V+	4	2	—	Positive (highest) power supply
V–	11	11	—	Negative (lowest) power supply
NC	—	3, 10	—	No connection

## 8 Specifications

### 8.1 Absolute Maximum Ratings

over operating free-air temperature range (unless otherwise noted)<sup>(1)</sup>

			MIN	MAX	UNIT
Supply voltage, $V_S$			±20 (40, single supply)		V
Signal input pins	Voltage <sup>(2)</sup>	Common-mode	(V–) – 0.5	(V+) + 0.5	V
		Differential <sup>(3)</sup>	±0.5		V
	Current		±10		mA
Output short circuit <sup>(4)</sup>			Continuous		
Temperature	Temperature range		–55	150	°C
	Junction temperature		150		°C
	Storage, $T_{stg}$		–65	150	°C

- (1) Stresses beyond those listed under *Absolute Maximum Ratings* may cause permanent damage to the device. These are stress ratings only, which do not imply functional operation of the device at these or any other conditions beyond those indicated under *Recommended Operating Conditions*. Exposure to absolute-maximum-rated conditions for extended periods may affect device reliability.
- (2) Transient conditions that exceed these voltage ratings should be current limited to 10 mA or less.
- (3) See the [Electrical Overstress](#) section for more information.
- (4) Short-circuit to ground, one amplifier per package.

### 8.2 ESD Ratings

			VALUE	UNIT
$V_{(ESD)}$	Electrostatic discharge	Human-body model (HBM), per ANSI/ESDA/JEDEC JS-001 <sup>(1)</sup>	±4000	V
		Charged-device model (CDM), per JEDEC specification JESD22-C101 <sup>(2)</sup>	±1000	

- (1) JEDEC document JEP155 states that 500-V HBM allows safe manufacturing with a standard ESD control process.
- (2) JEDEC document JEP157 states that 250-V CDM allows safe manufacturing with a standard ESD control process.

### 8.3 Recommended Operating Conditions

over operating free-air temperature range (unless otherwise noted)

	MIN	NOM	MAX	UNIT
Supply voltage ( $V_+ - V_-$ )	4.5 (±2.25)		36 (±18)	V
Specified temperature	–40		85	°C

#### 8.4 Thermal Information: OPA1688

THERMAL METRIC <sup>(1)</sup>		OPA1688		UNIT
		D (SOIC)	DRG (WSON)	
		8 PINS	8 PINS	
$R_{\theta JA}$	Junction-to-ambient thermal resistance	116.1	63.2	°C/W
$R_{\theta JC(top)}$	Junction-to-case (top) thermal resistance	69.8	63.5	°C/W
$R_{\theta JB}$	Junction-to-board thermal resistance	56.6	36.5	°C/W
$\psi_{JT}$	Junction-to-top characterization parameter	22.5	1.4	°C/W
$\psi_{JB}$	Junction-to-board characterization parameter	56.1	36.6	°C/W
$R_{\theta JC(bot)}$	Junction-to-case (bottom) thermal resistance	N/A	6.3	°C/W

(1) For more information about traditional and new thermal metrics, see the *Semiconductor and IC Package Thermal Metrics* application report, [SPRA953](#).

#### 8.5 Thermal Information: OPA1689

THERMAL METRIC <sup>(1)</sup>		OPA1689		UNIT
		D (SOIC)	RVA (VQFN)	
		14 PINS	16 PINS	
$R_{\theta JA}$	Junction-to-ambient thermal resistance	82.7	TBD	°C/W
$R_{\theta JC(top)}$	Junction-to-case (top) thermal resistance	42.3	TBD	°C/W
$R_{\theta JB}$	Junction-to-board thermal resistance	37.3	TBD	°C/W
$\psi_{JT}$	Junction-to-top characterization parameter	8.9	TBD	°C/W
$\psi_{JB}$	Junction-to-board characterization parameter	37	TBD	°C/W
$R_{\theta JC(bot)}$	Junction-to-case (bottom) thermal resistance	N/A	TBD	°C/W

(1) For more information about traditional and new thermal metrics, see the *Semiconductor and IC Package Thermal Metrics* application report, [SPRA953](#).

## 8.6 Electrical Characteristics

At  $T_A = 25^\circ\text{C}$ ,  $V_S = \pm 2.25\text{ V}$  to  $\pm 18\text{ V}$ ,  $V_{CM} = V_{OUT} = V_S / 2$ , and  $R_L = 10\text{ k}\Omega$  connected to  $V_S / 2$ , unless otherwise noted.

PARAMETER		TEST CONDITIONS	MIN	TYP	MAX	UNIT	
<b>AUDIO PERFORMANCE</b>							
THD+N	Total harmonic distortion + noise	$G = 1, f = 1\text{ kHz}, V_O = 3.5\text{ V}_{RMS}, R_L = 2\text{ k}\Omega$	0.00005%				
			-126			dB	
		$G = 1, f = 1\text{ kHz}, V_O = 3.5\text{ V}_{RMS}, R_L = 600\ \Omega$	0.000051%				
			-126			dB	
		$G = 1, f = 1\text{ kHz}, P_O = 10\text{ mW}, R_L = 128\ \Omega$	0.000153%				
			-116			dB	
$G = 1, f = 1\text{ kHz}, P_O = 10\text{ mW}, R_L = 32\ \Omega$	0.000357%						
	-109			dB			
$G = 1, f = 1\text{ kHz}, P_O = 10\text{ mW}, R_L = 16\ \Omega$	0.000616%						
	-104			dB			
<b>FREQUENCY RESPONSE</b>							
GBP	Gain bandwidth product	$G = 1$		10		MHz	
SR	Slew rate	$G = 1$		8		V/ $\mu\text{s}$	
	Full-power bandwidth <sup>(1)</sup>	$V_O = 1\text{ V}_{PP}$		1.3		MHz	
	Overload recovery time	$V_{IN} \times \text{gain} > V_S$		200		ns	
	Channel separation (dual)	$f = 1\text{ kHz}$		-120		dB	
$t_s$	Settling time	To 0.1%, $V_S = \pm 18\text{ V}, G = 1, 10\text{-V step}$		3		$\mu\text{s}$	
<b>NOISE</b>							
$E_n$	Input voltage noise	$f = 0.1\text{ Hz to } 10\text{ Hz}$		2.5		$\mu\text{V}_{PP}$	
$e_n$	Input voltage noise density <sup>(2)</sup>	$f = 100\text{ Hz}$		14		$\text{nV}/\sqrt{\text{Hz}}$	
		$f = 1\text{ kHz}$		8			
$i_n$	Input current noise density	$f = 1\text{ kHz}$		1.8		$\text{fA}/\sqrt{\text{Hz}}$	
<b>OFFSET VOLTAGE</b>							
$V_{OS}$	Input offset voltage	$T_A = 25^\circ\text{C}$		$\pm 0.25$	$\pm 1.5$	mV	
		$T_A = -40^\circ\text{C to } 85^\circ\text{C}$			$\pm 1.6$		
$dV_{OS}/dT$	$V_{OS}$ over temperature <sup>(2)</sup>	$T_A = -40^\circ\text{C to } 85^\circ\text{C}$		$\pm 0.5$	$\pm 2$	$\mu\text{V}/^\circ\text{C}$	
PSRR	Power-supply rejection ratio	$T_A = -40^\circ\text{C to } 85^\circ\text{C}$		$\pm 1$	$\pm 2.5$	$\mu\text{V}/\text{V}$	
			Channel separation, dc	At dc	0.1		$\mu\text{V}/\text{V}$
<b>INPUT BIAS CURRENT</b>							
$I_B$	Input bias current	$T_A = 25^\circ\text{C}$		$\pm 10$	$\pm 20$	pA	
		$T_A = -40^\circ\text{C to } 85^\circ\text{C}$			$\pm 1.5$	nA	
$I_{OS}$	Input offset current	$T_A = 25^\circ\text{C}$		$\pm 3$	$\pm 7$	pA	
		$T_A = -40^\circ\text{C to } 85^\circ\text{C}$			$\pm 250$	pA	
<b>INPUT VOLTAGE RANGE</b>							
$V_{CM}$	Common-mode voltage range <sup>(3)</sup>		$(V-) - 0.1\text{ V}$		$(V+) - 2\text{ V}$	V	
CMRR	Common-mode rejection ratio	$V_S = \pm 2.25\text{ V}, (V-) - 0.1\text{ V} < V_{CM} < (V+) - 2\text{ V}, T_A = -40^\circ\text{C to } 85^\circ\text{C}$	90	104		dB	
		$V_S = \pm 18\text{ V}, (V-) - 0.1\text{ V} < V_{CM} < (V+) - 2\text{ V}, T_A = -40^\circ\text{C to } 85^\circ\text{C}$	104	120			
<b>INPUT IMPEDANCE</b>							
	Differential			100    7		$\text{M}\Omega    \text{pF}$	
	Common-mode			6    1.5		$10^{12}\Omega    \text{pF}$	

(1) Full-power bandwidth =  $SR / (2\pi \times V_P)$ , where SR = slew rate.

(2) Specified by design and characterization.

(3) Common-mode range can extend to the top rail with reduced performance.

**Electrical Characteristics (continued)**

 At  $T_A = 25^\circ\text{C}$ ,  $V_S = \pm 2.25\text{ V}$  to  $\pm 18\text{ V}$ ,  $V_{CM} = V_{OUT} = V_S / 2$ , and  $R_L = 10\text{ k}\Omega$  connected to  $V_S / 2$ , unless otherwise noted.

PARAMETER	TEST CONDITIONS	MIN	TYP	MAX	UNIT
<b>OPEN-LOOP GAIN</b>					
$A_{OL}$	Open-loop voltage gain	$(V^-) + 0.35\text{ V} < V_O < (V^+) - 0.35\text{ V}$ , $R_L = 10\text{ k}\Omega$ , $T_A = -40^\circ\text{C}$ to $85^\circ\text{C}$	108	130	dB
		$(V^-) + 0.5\text{ V} < V_O < (V^+) - 0.5\text{ V}$ , $R_L = 2\text{ k}\Omega$ , $T_A = -40^\circ\text{C}$ to $85^\circ\text{C}$		118	
<b>OUTPUT</b>					
$V_O$	Voltage output swing from rail	$I_L = \pm 1\text{ mA}$	$(V^-) + 0.1\text{ V}$ $(V^+) - 0.1\text{ V}$		mV
		$V_S = 36\text{ V}$ , $R_L = 10\text{ k}\Omega$	70	90	
		$V_S = 36\text{ V}$ , $R_L = 2\text{ k}\Omega$	330	400	
$Z_O$	Open-loop output impedance	$f = 1\text{ MHz}$ , $I_O = 0\text{ A}$	60		$\Omega$
$I_{SC}$	Short-circuit current		$\pm 75$		mA
$C_{LOAD}$	Capacitive load drive		See the <a href="#">Typical Characteristics</a>		pF
<b>POWER SUPPLY</b>					
$V_S$	Specified voltage range		4.5	36	V
$I_Q$	Quiescent current per amplifier	$I_O = 0\text{ A}$	1.6	1.8	mA
		$I_O = 0\text{ A}$ , $T_A = -40^\circ\text{C}$ to $85^\circ\text{C}$		2	
<b>TEMPERATURE RANGE</b>					
	Specified range		-40	85	$^\circ\text{C}$
	Operating range		-55	125	$^\circ\text{C}$

## 8.7 Typical Characteristics: Table of Graphs

**Table 1. List of Typical Characteristics**

DESCRIPTION	FIGURE
Offset Voltage Production Distribution	<a href="#">Figure 1</a>
Offset Voltage Drift Distribution	<a href="#">Figure 2</a>
Offset Voltage vs Temperature ( $V_S = \pm 18\text{ V}$ )	<a href="#">Figure 3</a>
Offset Voltage vs Common-Mode Voltage ( $V_S = \pm 18\text{ V}$ )	<a href="#">Figure 4</a>
Offset Voltage vs Common-Mode Voltage (Upper Stage)	<a href="#">Figure 5</a>
Offset Voltage vs Power Supply	<a href="#">Figure 6</a>
Input Bias Current vs Common-Mode Voltage	<a href="#">Figure 7</a>
Input Bias Current vs Temperature	<a href="#">Figure 8</a>
Output Voltage Swing vs Output Current (Maximum Supply)	<a href="#">Figure 9</a>
CMRR and PSRR vs Frequency (Referred-to-Input)	<a href="#">Figure 10</a>
CMRR vs Temperature	<a href="#">Figure 11</a>
PSRR vs Temperature	<a href="#">Figure 12</a>
0.1-Hz to 10-Hz Noise	<a href="#">Figure 13</a>
Input Voltage Noise Spectral Density vs Frequency	<a href="#">Figure 14</a>
THD+N Ratio vs Frequency	<a href="#">Figure 15</a>
THD+N vs Output Amplitude	<a href="#">Figure 16</a>
THD+N vs Frequency	<a href="#">Figure 17</a>
THD+N vs Amplitude	<a href="#">Figure 18</a>
Quiescent Current vs Temperature	<a href="#">Figure 19</a>
Quiescent Current vs Supply Voltage	<a href="#">Figure 20</a>
Open-Loop Gain and Phase vs Frequency	<a href="#">Figure 21</a>
Closed-Loop Gain vs Frequency	<a href="#">Figure 22</a>
Open-Loop Gain vs Temperature	<a href="#">Figure 23</a>
Open-Loop Output Impedance vs Frequency	<a href="#">Figure 24</a>
Small-Signal Overshoot vs Capacitive Load (100-mV Output Step)	<a href="#">Figure 25</a> , <a href="#">Figure 26</a>
Positive Overload Recovery	<a href="#">Figure 27</a> , <a href="#">Figure 28</a>
Negative Overload Recovery	<a href="#">Figure 29</a> , <a href="#">Figure 30</a>
Small-Signal Step Response (10 mV, $G = -1$ )	<a href="#">Figure 31</a>
Small-Signal Step Response (10 mV, $G = 1$ )	<a href="#">Figure 32</a>
Small-Signal Step Response (100 mV, $G = -1$ )	<a href="#">Figure 33</a>
Small-Signal Step Response (100 mV, $G = 1$ )	<a href="#">Figure 34</a>
Large-Signal Step Response (10 V, $G = -1$ )	<a href="#">Figure 35</a>
Large-Signal Step Response (10 V, $G = 1$ )	<a href="#">Figure 36</a>
Large-Signal Settling Time (10-V Positive Step)	<a href="#">Figure 37</a>
Large-Signal Settling Time (10-V Negative Step)	<a href="#">Figure 38</a>
No Phase Reversal	<a href="#">Figure 39</a>
Short-Circuit Current vs Temperature	<a href="#">Figure 40</a>
Maximum Output Voltage vs Frequency	<a href="#">Figure 41</a>
EMIRR vs Frequency	<a href="#">Figure 42</a>
Channel Separation vs Frequency	<a href="#">Figure 43</a>

### 8.8 Typical Characteristics

$V_S = \pm 18\text{ V}$ ,  $V_{CM} = V_S / 2$ ,  $R_{LOAD} = 10\text{ k}\Omega$  connected to  $V_S / 2$ , and  $C_L = 100\text{ pF}$ , unless otherwise noted.

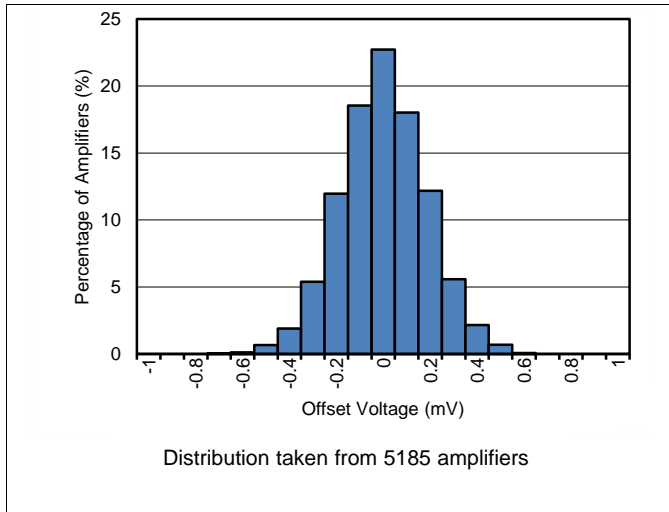

Figure 1. Offset Voltage Production Distribution

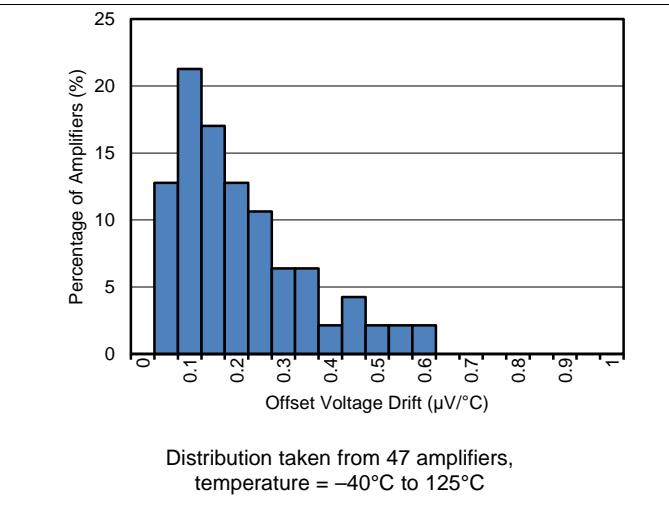

Figure 2. Offset Voltage Drift Production Distribution

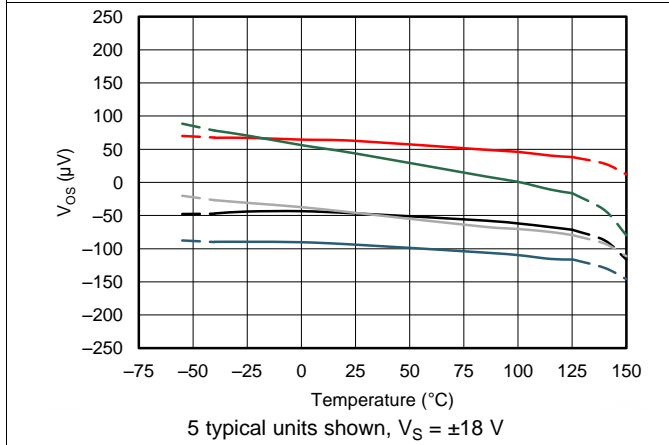

Figure 3. Offset Voltage vs Temperature ( $V_S = \pm 18\text{ V}$ )

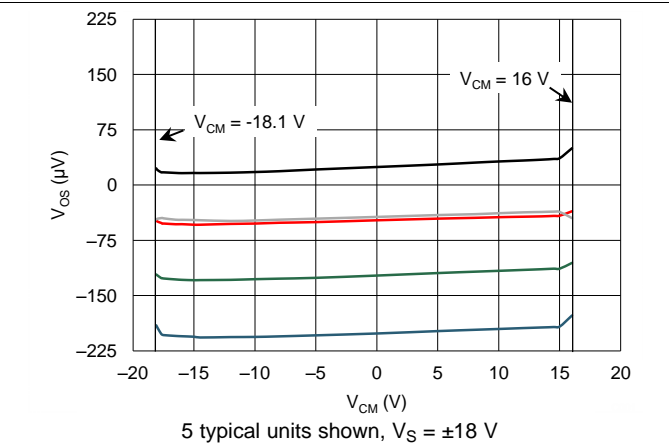

Figure 4. Offset Voltage vs Common-Mode Voltage ( $V_S = \pm 18\text{ V}$ )

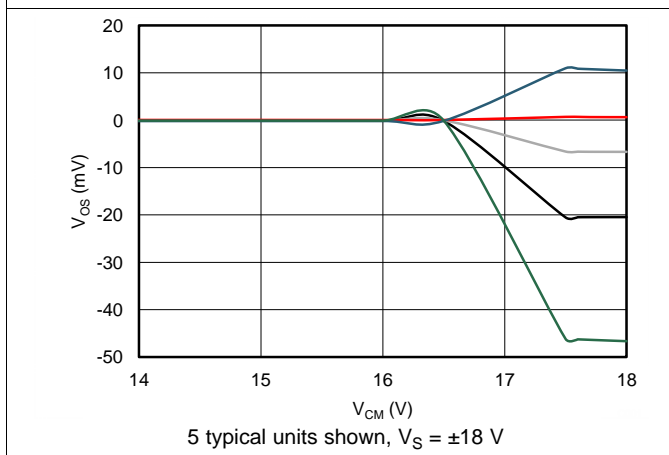

Figure 5. Offset Voltage vs Common-Mode Voltage (Upper Stage)

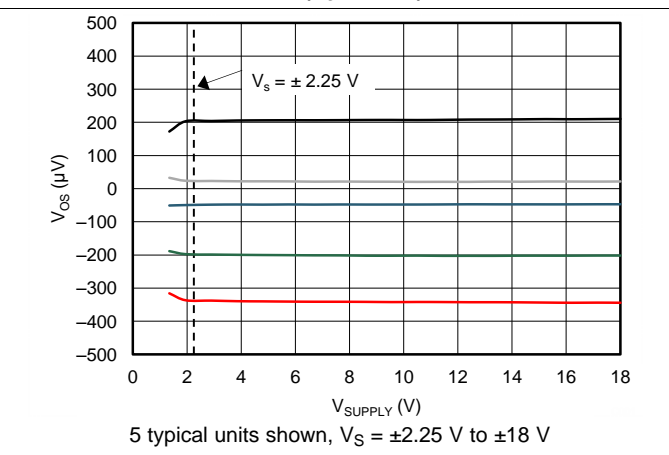

Figure 6. Offset Voltage vs Power Supply

Typical Characteristics (continued)

$V_S = \pm 18\text{ V}$ ,  $V_{CM} = V_S / 2$ ,  $R_{LOAD} = 10\text{ k}\Omega$  connected to  $V_S / 2$ , and  $C_L = 100\text{ pF}$ , unless otherwise noted.

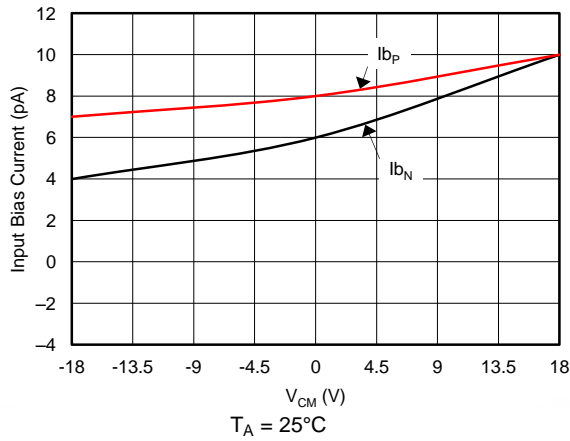

Figure 7. Input Bias Current vs Common-Mode Voltage

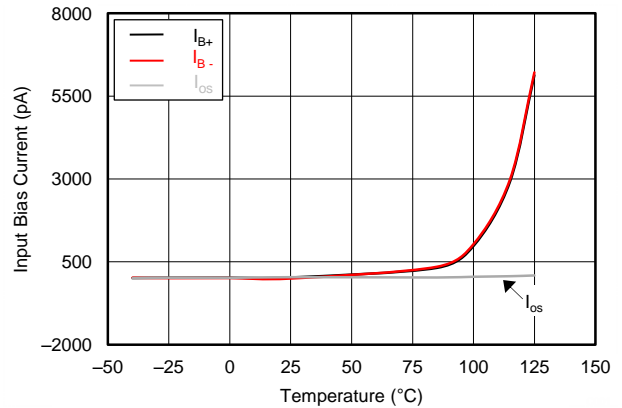

Figure 8. Input Bias Current vs Temperature

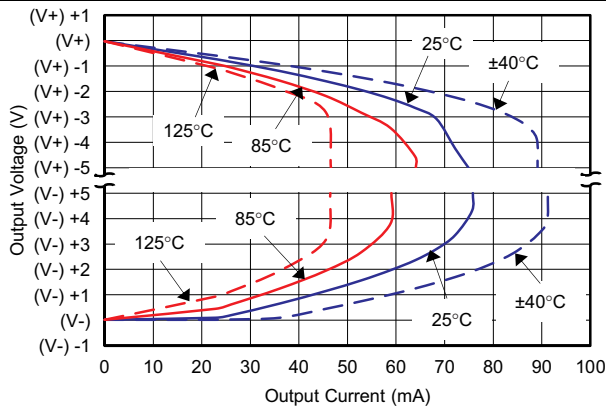

Figure 9. Output Voltage Swing vs Output Current (Maximum Supply)

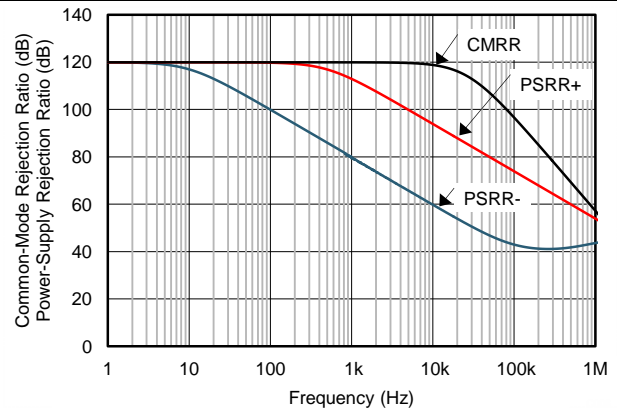

Figure 10. CMRR and PSRR vs Frequency (Referred-to-Input)

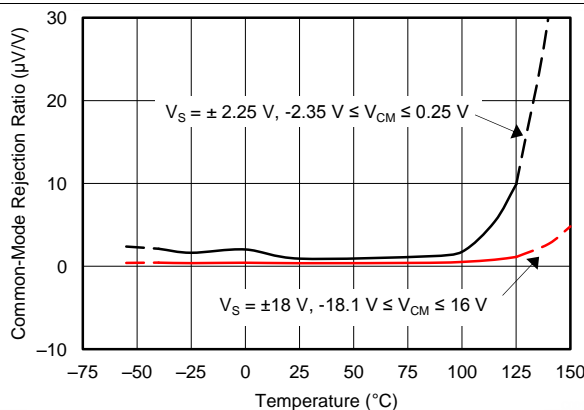

Figure 11. CMRR vs Temperature

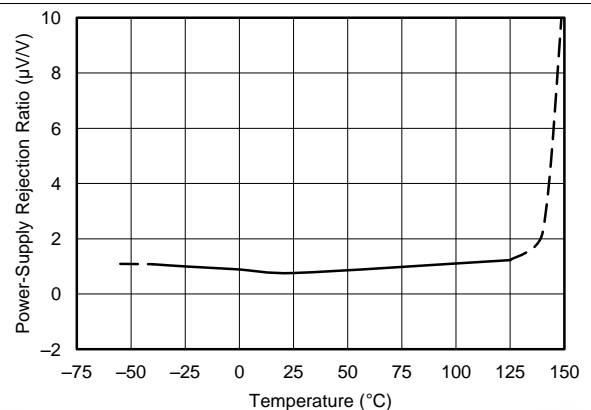
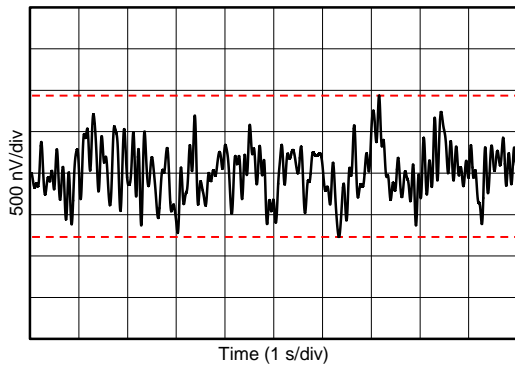

Figure 12. PSRR vs Temperature

Typical Characteristics (continued)

$V_S = \pm 18\text{ V}$ ,  $V_{CM} = V_S / 2$ ,  $R_{LOAD} = 10\text{ k}\Omega$  connected to  $V_S / 2$ , and  $C_L = 100\text{ pF}$ , unless otherwise noted.



Peak-to-peak noise =  $1.70\ \mu\text{V}_{PP}$

Figure 13. 0.1-Hz to 10-Hz Noise

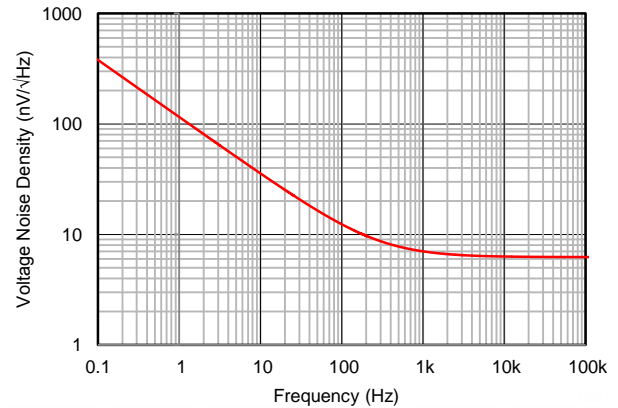
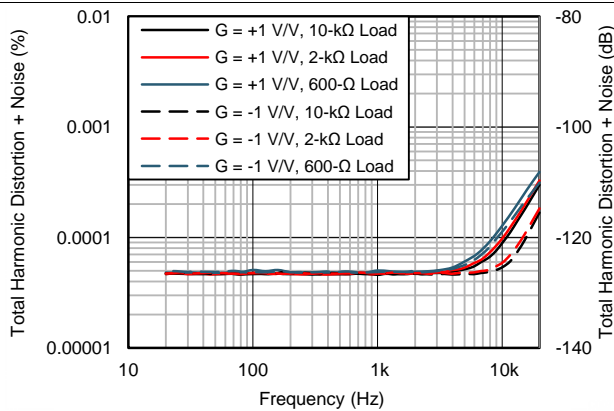
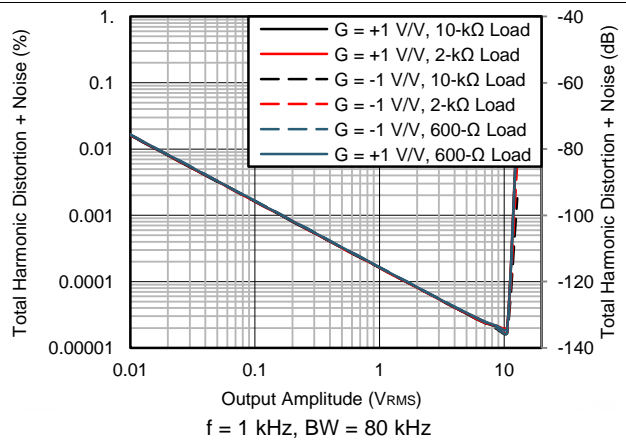

Figure 14. Input Voltage Noise Spectral Density vs Frequency



$V_{OUT} = 3.5\ V_{RMS}$ ,  $BW = 50\text{ kHz}$

Figure 15. THD+N Ratio vs Frequency



$f = 1\text{ kHz}$ ,  $BW = 80\text{ kHz}$

Figure 16. THD+N vs Output Amplitude

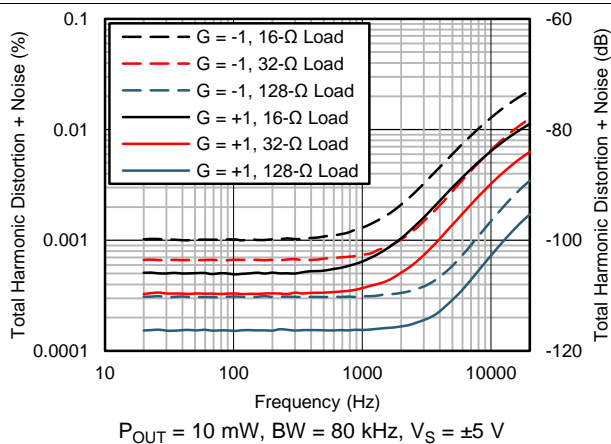

$P_{OUT} = 10\text{ mW}$ ,  $BW = 80\text{ kHz}$ ,  $V_S = \pm 5\text{ V}$

Figure 17. THD+N vs Frequency

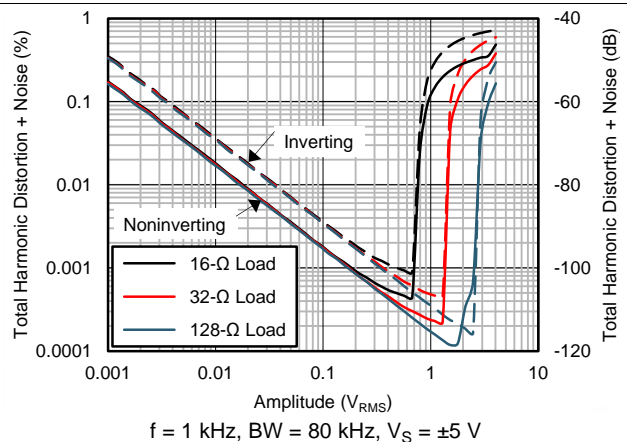

$f = 1\text{ kHz}$ ,  $BW = 80\text{ kHz}$ ,  $V_S = \pm 5\text{ V}$

Figure 18. THD+N vs Amplitude

Typical Characteristics (continued)

$V_S = \pm 18\text{ V}$ ,  $V_{CM} = V_S / 2$ ,  $R_{LOAD} = 10\text{ k}\Omega$  connected to  $V_S / 2$ , and  $C_L = 100\text{ pF}$ , unless otherwise noted.

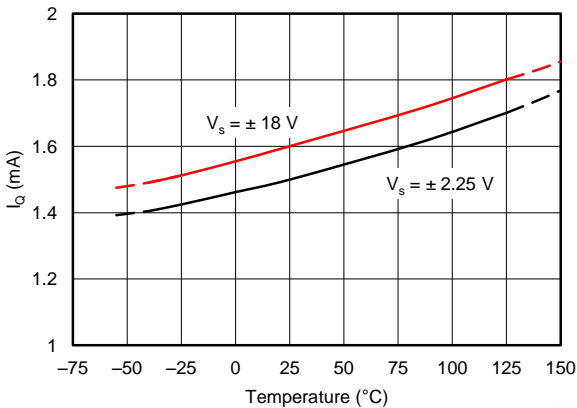

Figure 19. Quiescent Current vs Temperature

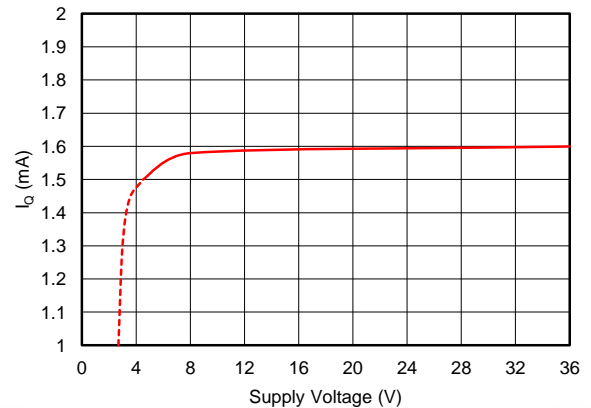

Figure 20. Quiescent Current vs Supply Voltage

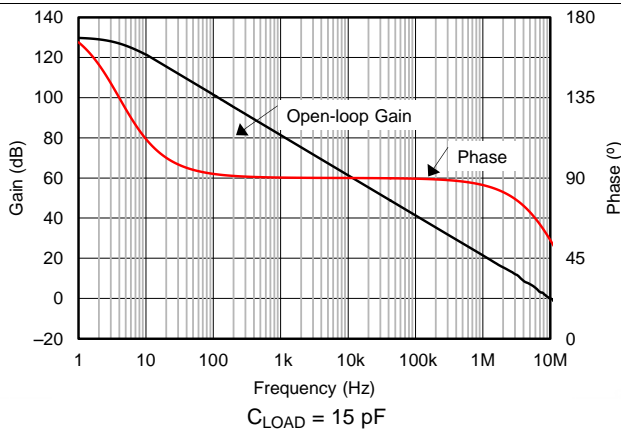

Figure 21. Open-Loop Gain and Phase vs Frequency

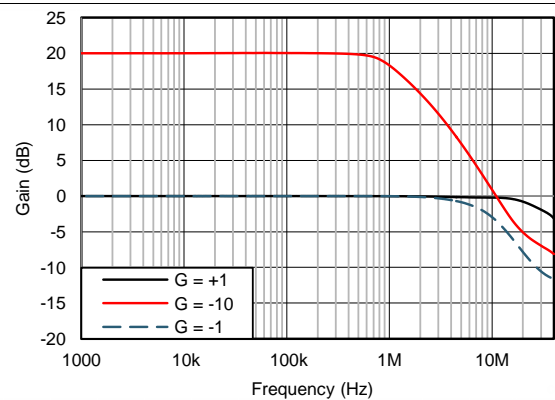

Figure 22. Closed-Loop Gain vs Frequency

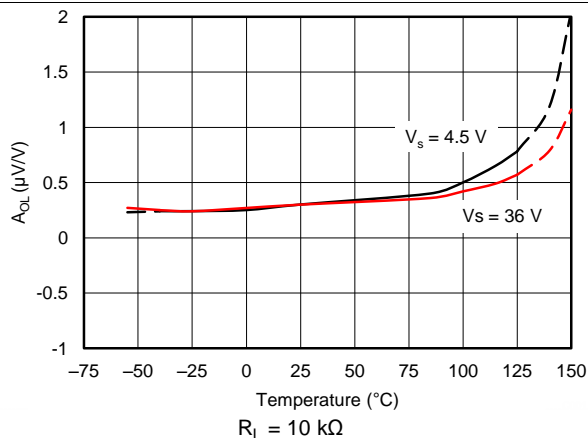

Figure 23. Open-Loop Gain vs Temperature

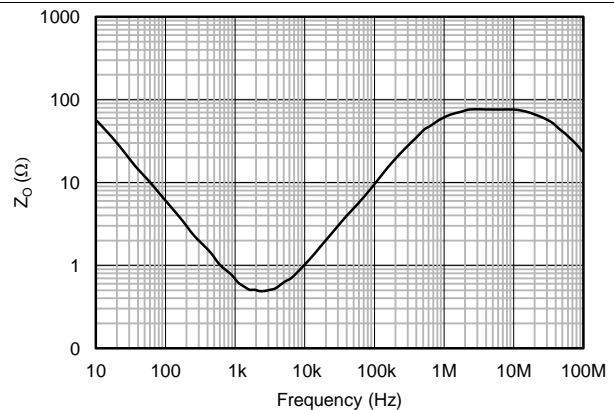
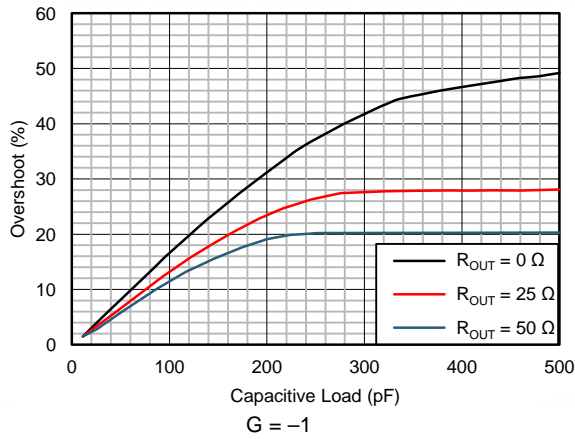

Figure 24. Open-Loop Output Impedance vs Frequency

**Typical Characteristics (continued)**

$V_S = \pm 18\text{ V}$ ,  $V_{CM} = V_S / 2$ ,  $R_{LOAD} = 10\text{ k}\Omega$  connected to  $V_S / 2$ , and  $C_L = 100\text{ pF}$ , unless otherwise noted.



**Figure 25. Small-Signal Overshoot vs Capacitive Load (100-mV Output Step)**

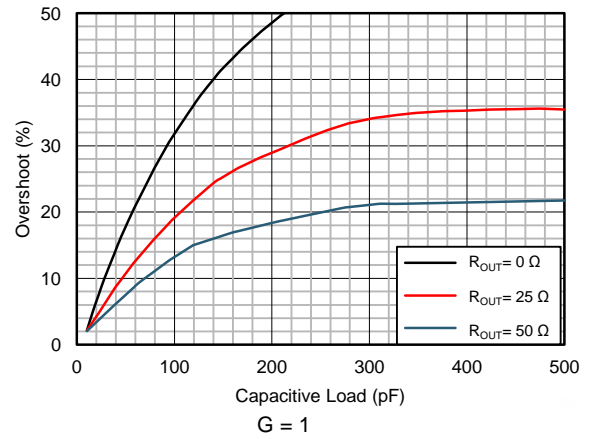

**Figure 26. Small-Signal Overshoot vs Capacitive Load (100-mV Output Step)**

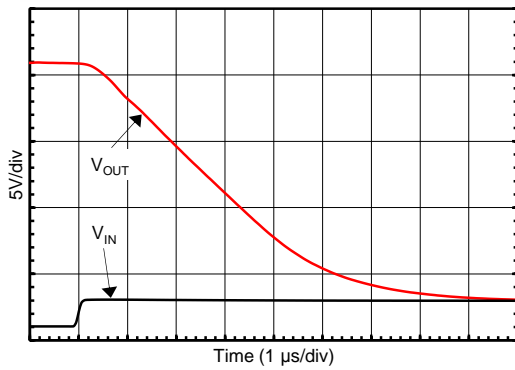

**Figure 27. Positive Overload Recovery**

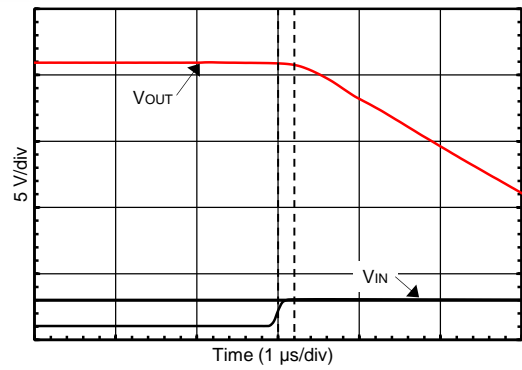

**Figure 28. Positive Overload Recovery (Zoomed In)**

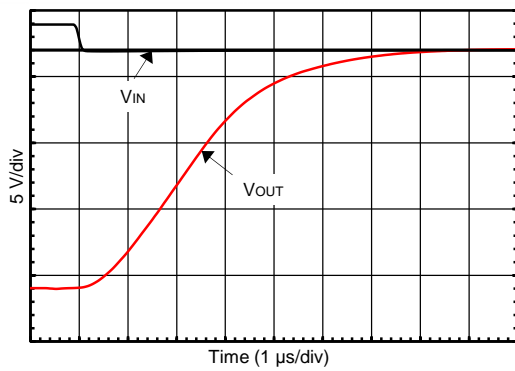

**Figure 29. Negative Overload Recovery**

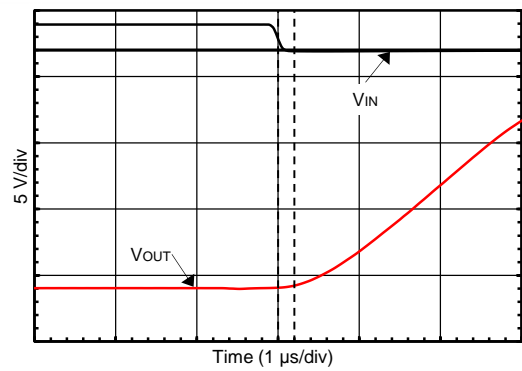

**Figure 30. Negative Overload Recovery (Zoomed In)**

Typical Characteristics (continued)

$V_S = \pm 18\text{ V}$ ,  $V_{CM} = V_S / 2$ ,  $R_{LOAD} = 10\text{ k}\Omega$  connected to  $V_S / 2$ , and  $C_L = 100\text{ pF}$ , unless otherwise noted.

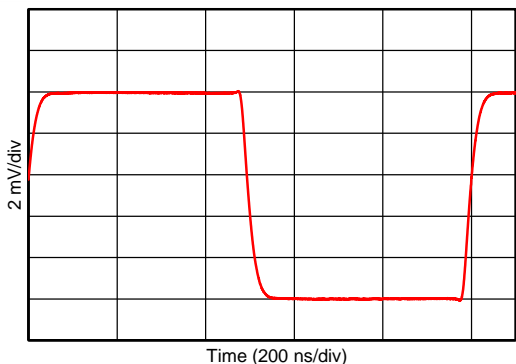

$R_L = 1\text{ k}\Omega$ ,  $C_L = 10\text{ pF}$

Figure 31. Small-Signal Step Response (10 mV,  $G = -1$ )

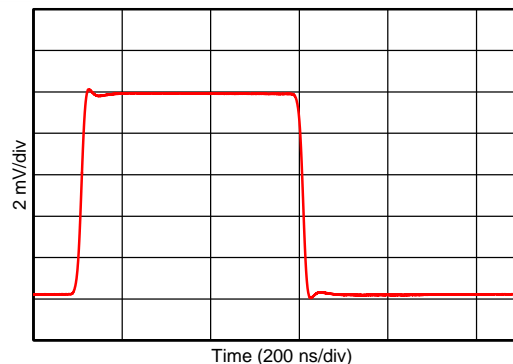

$C_L = 10\text{ pF}$

Figure 32. Small-Signal Step Response (10 mV,  $G = 1$ )

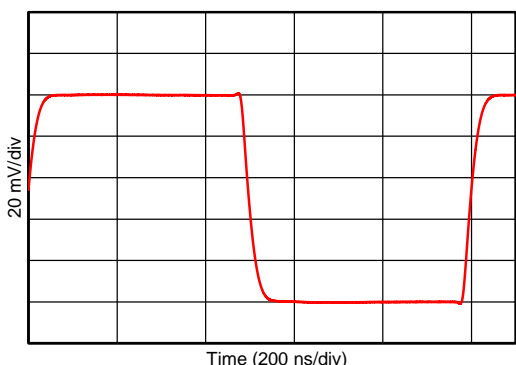

$R_L = 1\text{ k}\Omega$ ,  $C_L = 10\text{ pF}$

Figure 33. Small-Signal Step Response (100 mV,  $G = -1$ )

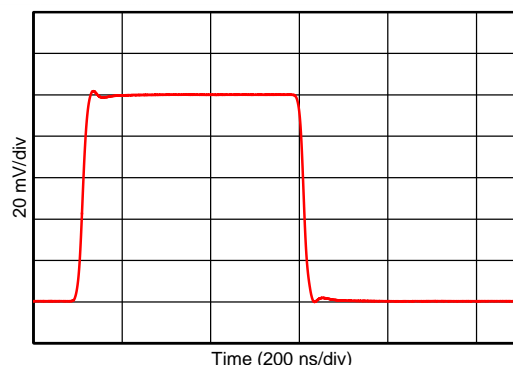

$C_L = 10\text{ pF}$

Figure 34. Small-Signal Step Response (100 mV,  $G = 1$ )

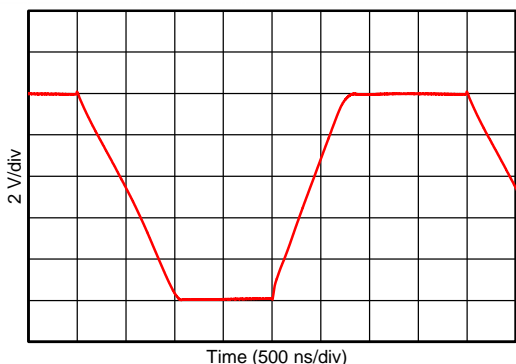

$R_L = 1\text{ k}\Omega$ ,  $C_L = 10\text{ pF}$

Figure 35. Large-Signal Step Response (10 V,  $G = -1$ )

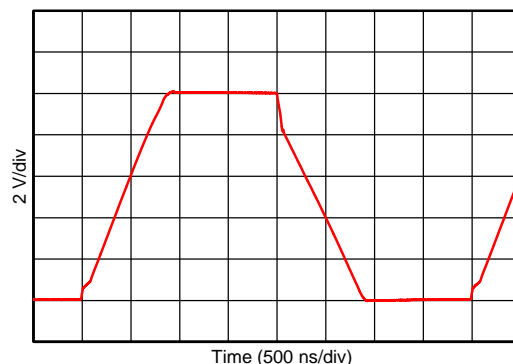

$C_L = 10\text{ pF}$

Figure 36. Large-Signal Step Response (10 V,  $G = 1$ )

**Typical Characteristics (continued)**

$V_S = \pm 18\text{ V}$ ,  $V_{CM} = V_S / 2$ ,  $R_{LOAD} = 10\text{ k}\Omega$  connected to  $V_S / 2$ , and  $C_L = 100\text{ pF}$ , unless otherwise noted.

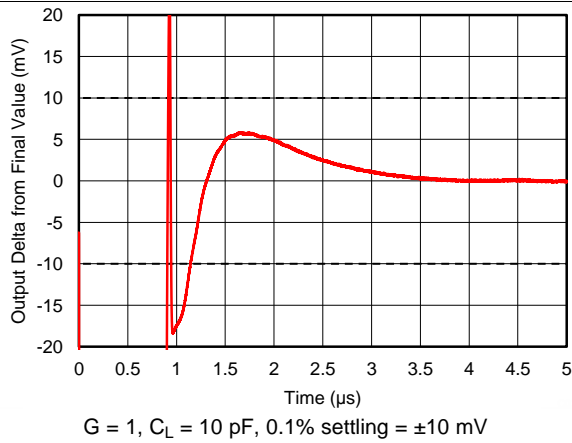

**Figure 37. Large-Signal Settling Time (10-V Positive Step)**

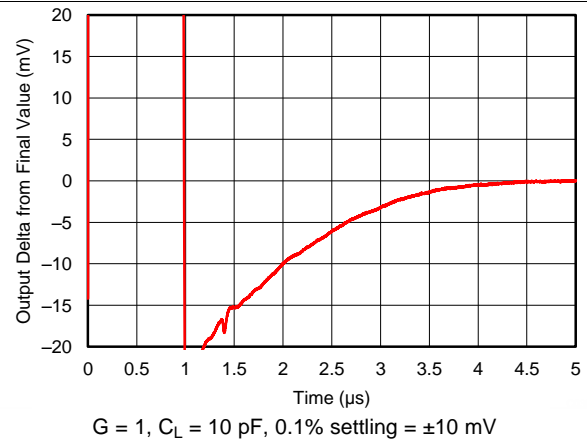

**Figure 38. Large-Signal Settling Time (10-V Negative Step)**

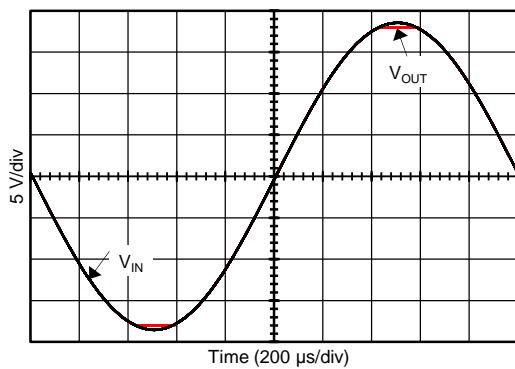

**Figure 39. No Phase Reversal**

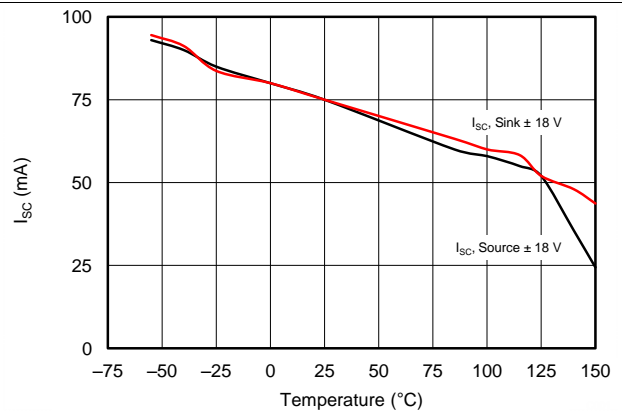

**Figure 40. Short-Circuit Current vs Temperature**

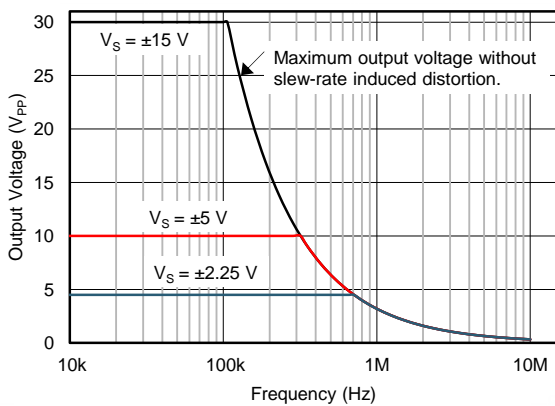

**Figure 41. Maximum Output Voltage vs Frequency**

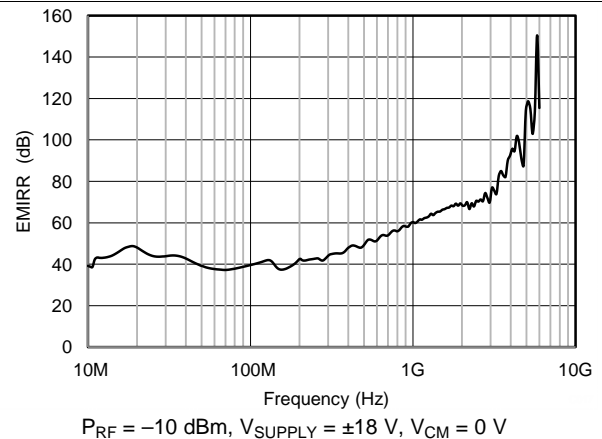

**Figure 42. EMIRR vs Frequency**

**Typical Characteristics (continued)**

$V_S = \pm 18\text{ V}$ ,  $V_{CM} = V_S / 2$ ,  $R_{LOAD} = 10\text{ k}\Omega$  connected to  $V_S / 2$ , and  $C_L = 100\text{ pF}$ , unless otherwise noted.

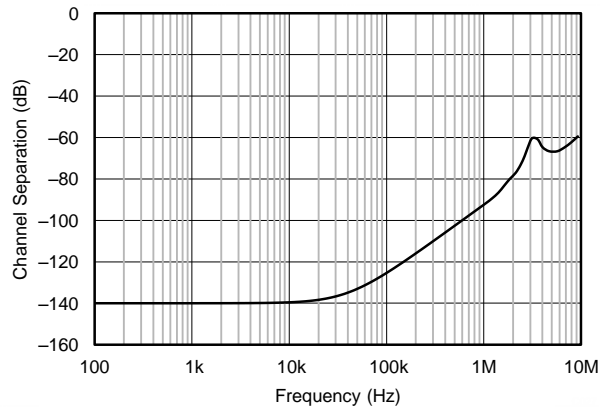

**Figure 43. Channel Separation vs Frequency**

## 9 Detailed Description

### 9.1 Overview

The OPA168x family of operational amplifiers provide high overall performance, making them ideal for many general-purpose applications. The excellent offset drift of only  $1.5 \mu\text{V}/^\circ\text{C}$  (max) provides excellent stability over the entire temperature range. In addition, the device offers very good overall performance with high CMRR, PSRR,  $A_{OL}$ , and superior THD.

The [Functional Block Diagram](#) section shows the simplified diagram of the OPA168x design. The design topology is a highly-optimized, three-stage amplifier with an active-feedforward gain stage.

### 9.2 Functional Block Diagram

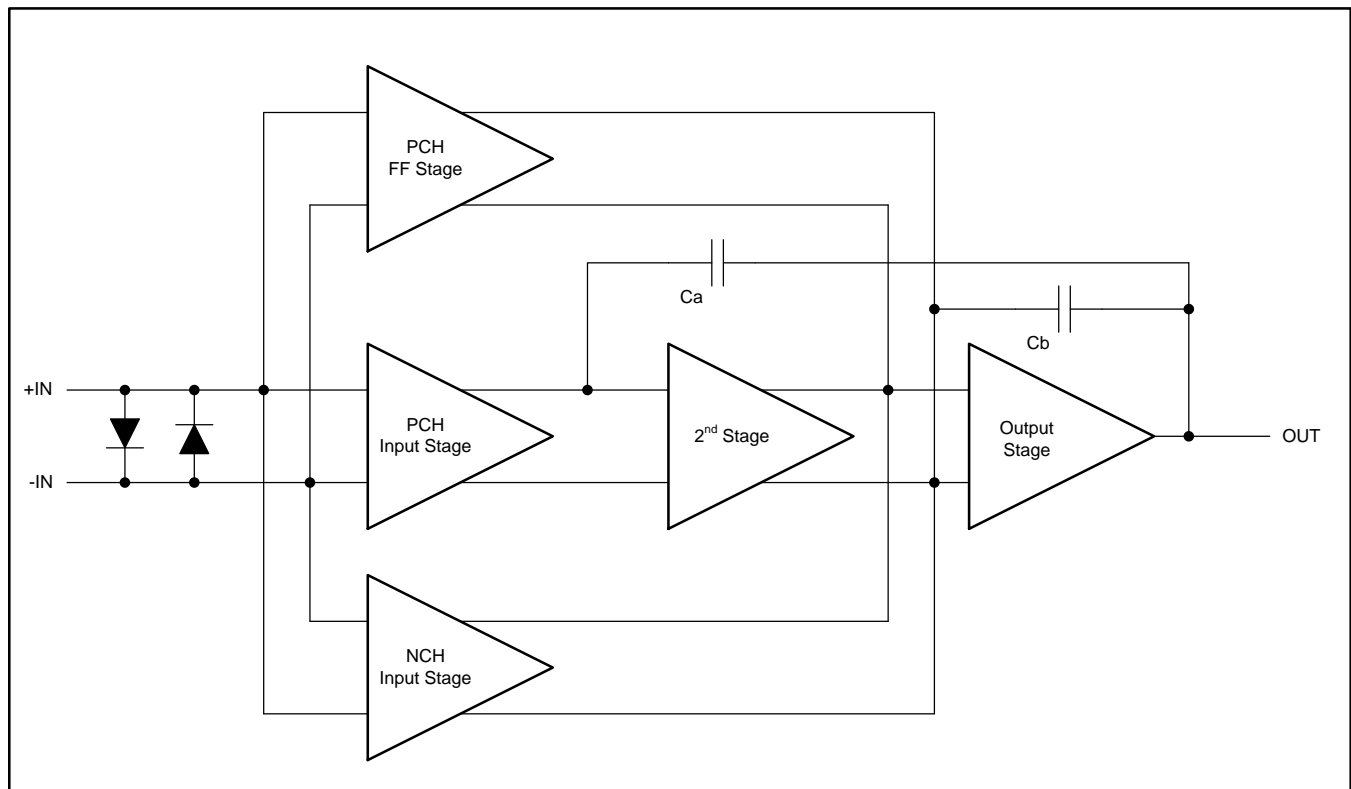

## 9.3 Feature Description

### 9.3.1 EMI Rejection

The OPA168x uses integrated electromagnetic interference (EMI) filtering to reduce the effects of EMI from sources such as wireless communications and densely-populated boards with a mix of analog signal chain and digital components. EMI immunity can be improved with circuit design techniques; the OPA168x benefits from these design improvements. Texas Instruments has developed the ability to accurately measure and quantify the immunity of an operational amplifier over a broad frequency spectrum extending from 10 MHz to 6 GHz. Figure 44 shows the results of this testing on the OPA168x. Table 2 shows the EMIRR IN+ values for the OPA168x at particular frequencies commonly encountered in real-world applications. Applications listed in Table 2 can be centered on or operated near the particular frequency shown. Detailed information can also be found in application report SBOA128, *EMI Rejection Ratio of Operational Amplifiers*, available for download from [www.ti.com](http://www.ti.com).

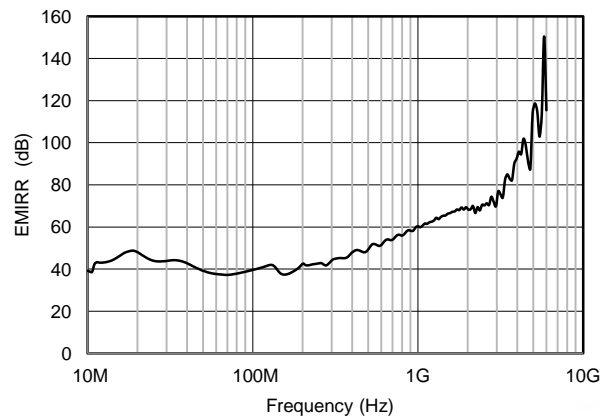

$$P_{RF} = -10 \text{ dBm}, V_{SUPPLY} = \pm 18 \text{ V}, V_{CM} = 0 \text{ V}$$

Figure 44. EMIRR Testing

Table 2. OPAX168x EMIRR IN+ for Frequencies of Interest

FREQUENCY	APPLICATION OR ALLOCATION	EMIRR IN+
400 MHz	Mobile radio, mobile satellite, space operation, weather, radar, and ultrahigh frequency (UHF) applications	47.6 dB
900 MHz	Global system for mobile communications (GSM) applications, radio communication, navigation, GPS (to 1.6 GHz), GSM, aeronautical mobile, and UHF applications	58.5 dB
1.8 GHz	GSM applications, mobile personal communications, broadband, satellite, and L-band (1 GHz to 2 GHz)	68 dB
2.4 GHz	802.11b, 802.11g, 802.11n, Bluetooth®, mobile personal communications, industrial, scientific and medical (ISM) radio band, amateur radio and satellite, and S-band (2 GHz to 4 GHz)	69.2 dB
3.6 GHz	Radiolocation, aero communication and navigation, satellite, mobile, and S-band	82.9 dB
5.0 GHz	802.11a, 802.11n, aero communication and navigation, mobile communication, space and satellite operation, and C-band (4 GHz to 8 GHz)	114 dB

### 9.3.2 Phase-Reversal Protection

The OPA168x family has internal phase-reversal protection. Many op amps exhibit phase reversal when the input is driven beyond the linear common-mode range. This condition is most often encountered in noninverting circuits when the input is driven beyond the specified common-mode voltage range, causing the output to reverse into the opposite rail. The input of the OPA168x prevents phase reversal with excessive common-mode voltage. Instead, the appropriate rail limits the output voltage. This performance is shown in Figure 45.

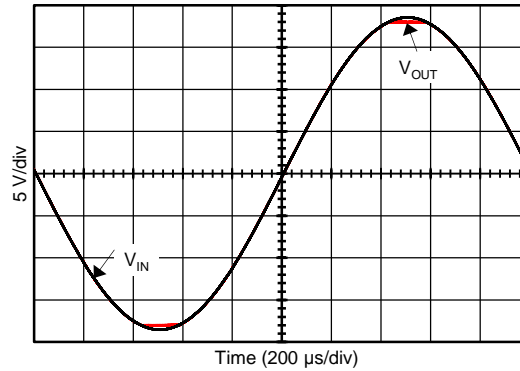

Figure 45. No Phase Reversal

### 9.3.3 Capacitive Load and Stability

The dynamic characteristics of the OPA168x are optimized for commonly-used operating conditions. The combination of low closed-loop gain and high capacitive loads decreases the phase margin of the amplifier and may lead to gain peaking or oscillations. As a result, heavier capacitive loads must be isolated from the output. The simplest way to achieve this isolation is to add a small resistor (for example,  $R_{OUT} = 50 \Omega$ ) in series with the output. Figure 46 and Figure 47 show graphs of small-signal overshoot versus capacitive load for several values of  $R_{OUT}$ ; see application bulletin SBOA015 (AB-028), *Feedback Plots Define Op Amp AC Performance*, available for download from [www.ti.com](http://www.ti.com), for details of analysis techniques and application circuits.

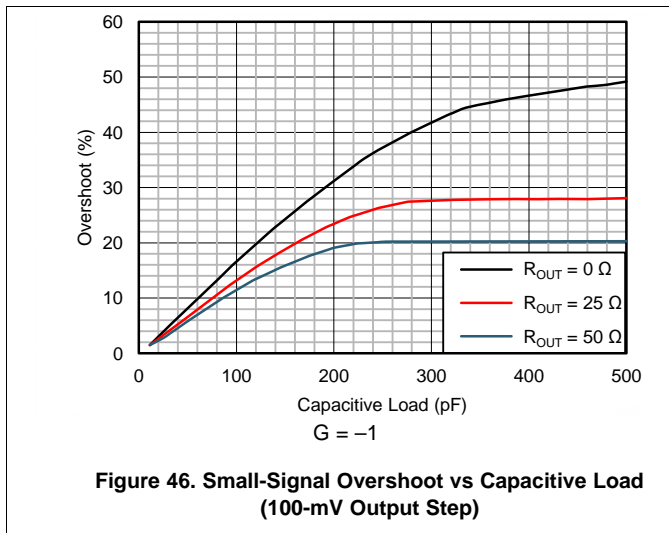

Figure 46. Small-Signal Overshoot vs Capacitive Load (100-mV Output Step)

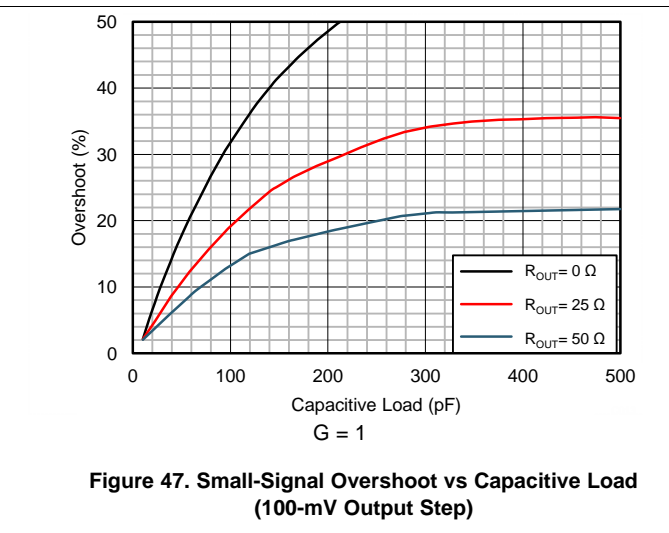

Figure 47. Small-Signal Overshoot vs Capacitive Load (100-mV Output Step)

## 9.4 Device Functional Modes

### 9.4.1 Common-Mode Voltage Range

The input common-mode voltage range of the OPA168x series extends 100 mV below the negative rail and within 2 V of the top rail for normal operation.

This device can operate with full rail-to-rail input 100 mV beyond the top rail, but with reduced performance within 2 V of the top rail. The typical performance in this range is summarized in [Table 3](#).

**Table 3. Typical Performance Range ( $V_S = \pm 18$  V)**

PARAMETER	MIN	TYP	MAX	UNIT
Input common-mode voltage	$(V+) - 2$		$(V+) + 0.1$	V
Offset voltage		5		mV
Offset voltage vs temperature ( $T_A = -40^\circ\text{C}$ to $85^\circ\text{C}$ )		10		$\mu\text{V}/^\circ\text{C}$
Common-mode rejection		70		dB
Open-loop gain		60		dB
Gain bandwidth product (GBP)		4		MHz
Slew rate		4		V/ $\mu\text{s}$
Noise at $f = 1$ kHz		22		$\text{nV}/\sqrt{\text{Hz}}$

### 9.4.2 Electrical Overstress

Designers often ask questions about the capability of an operational amplifier to withstand electrical overstress. These questions tend to focus on the device inputs, but can involve the supply voltage pins or even the output pin. Each of these different pin functions have electrical stress limits determined by the voltage breakdown characteristics of the particular semiconductor fabrication process and specific circuits connected to the pin. Additionally, internal electrostatic discharge (ESD) protection is built into these circuits to protect them from accidental ESD events both before and during product assembly.

A good understanding of this basic ESD circuitry and its relevance to an electrical overstress event is helpful. [Figure 48](#) illustrates the ESD circuits contained in the OPA168x (indicated by the dashed line area). The ESD protection circuitry involves several current-steering diodes connected from the input and output pins and routed back to the internal power-supply lines, where the diodes meet at an absorption device internal to the operational amplifier. This protection circuitry is intended to remain inactive during normal circuit operation.

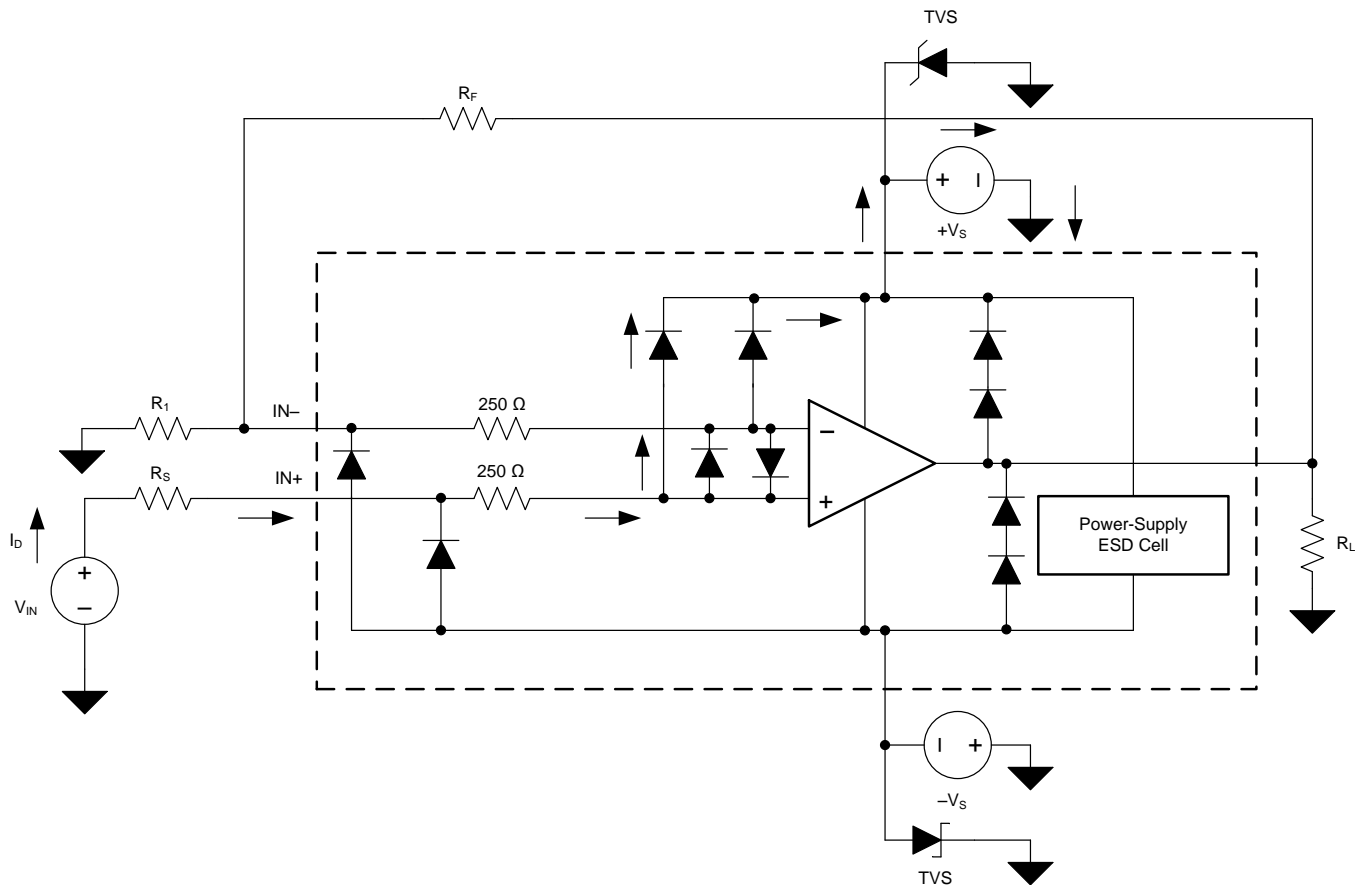

**Figure 48. Equivalent Internal ESD Circuitry Relative to a Typical Circuit Application**

An ESD event produces a short-duration, high-voltage pulse that is transformed into a short-duration, high-current pulse when discharging through a semiconductor device. The ESD protection circuits are designed to provide a current path around the operational amplifier core to prevent damage. The energy absorbed by the protection circuitry is then dissipated as heat.

When an ESD voltage develops across two or more amplifier device pins, current flows through one or more steering diodes. Depending on the path that the current takes, the absorption device can activate. The absorption device has a trigger, or threshold voltage, that is above the normal operating voltage of the OPA168x but below the device breakdown voltage level. When this threshold is exceeded, the absorption device quickly activates and clamps the voltage across the supply rails to a safe level.

When the operational amplifier connects into a circuit (Figure 48), the ESD protection components are intended to remain inactive and do not become involved in the application circuit operation. However, circumstances may arise where an applied voltage exceeds the operating voltage range of a given pin. If this condition occurs, there is a risk that some internal ESD protection circuits can turn on and conduct current. Any such current flow occurs through steering-diode paths and rarely involves the absorption device.

Figure 48 shows a specific example where the input voltage ( $V_{IN}$ ) exceeds the positive supply voltage ( $+V_S$ ) by 500 mV or more. Much of what happens in the circuit depends on the supply characteristics. If  $+V_S$  can sink the current, one of the upper input steering diodes conducts and directs current to  $+V_S$ . Excessively high current levels can flow with increasingly higher  $V_{IN}$ . As a result, the data sheet specifications recommend that applications limit the input current to 10 mA.

If the supply is not capable of sinking the current,  $V_{IN}$  can begin sourcing current to the operational amplifier and then take over as the source of positive supply voltage. The danger in this case is that the voltage can rise to levels that exceed the operational amplifier absolute maximum ratings.

Another common question involves what happens to the amplifier if an input signal is applied to the input when the power supplies ( $+V_S$  or  $-V_S$ ) are at 0 V. Again, this question depends on the supply characteristic when at 0 V, or at a level below the input-signal amplitude. If the supplies appear as high impedance, then the input source supplies the operational amplifier current through the current-steering diodes. This state is not a normal bias condition; most likely, the amplifier will not operate normally. If the supplies are low impedance, then the current through the steering diodes can become quite high. The current level depends on the ability of the input source to deliver current, and any resistance in the input path.

If there is any uncertainty about the ability of the supply to absorb this current, add external zener diodes to the supply pins; see [Figure 48](#). Select the zener voltage so that the diode does not turn on during normal operation. However, the zener voltage must be low enough so that the zener diode conducts if the supply pin begins to rise above the safe-operating, supply-voltage level.

The OPA168x input pins are protected from excessive differential voltage with back-to-back diodes; see [Figure 48](#). In most circuit applications, the input protection circuitry has no effect. However, in low-gain or  $G = 1$  circuits, fast-ramping input signals can forward-bias these diodes because the output of the amplifier cannot respond rapidly enough to the input ramp. If the input signal is fast enough to create this forward-bias condition, limit the input signal current to 10 mA or less. If the input signal current is not inherently limited, an input series resistor can be used to limit the input signal current. This input series resistor degrades the low-noise performance of the OPA168x. [Figure 48](#) illustrates an example configuration that implements a current-limiting feedback resistor.

### 9.4.3 Overload Recovery

Overload recovery is defined as the time required for the op amp output to recover from the saturated state to the linear state. The output devices of the op amp enter the saturation region when the output voltage exceeds the rated operating voltage, either resulting from the high input voltage or the high gain. After the device enters the saturation region, the charge carriers in the output devices need time to return back to the normal state. After the charge carriers return back to the equilibrium state, the device begins to slew at the normal slew rate. Thus, the propagation delay in case of an overload condition is the sum of the overload recovery time and the slew time. The overload recovery time for the OPA168x is approximately 200 ns.

## 10 Applications and Implementation

### NOTE

Information in the following applications sections is not part of the TI component specification, and TI does not warrant its accuracy or completeness. TI's customers are responsible for determining suitability of components for their purposes. Customers should validate and test their design implementation to confirm system functionality.

### 10.1 Application Information

The OPA168x family of amplifiers is specified for operation from 4.5 V to 36 V ( $\pm 2.25$  V to  $\pm 18$  V). Many of the specifications apply from  $-40^{\circ}\text{C}$  to  $85^{\circ}\text{C}$ . Parameters that can exhibit significant variance with regard to operating voltage or temperature are presented in the *Typical Characteristics*.

### 10.2 Typical Application

This application example highlights only a few of the circuits where the OPA168x can be used.

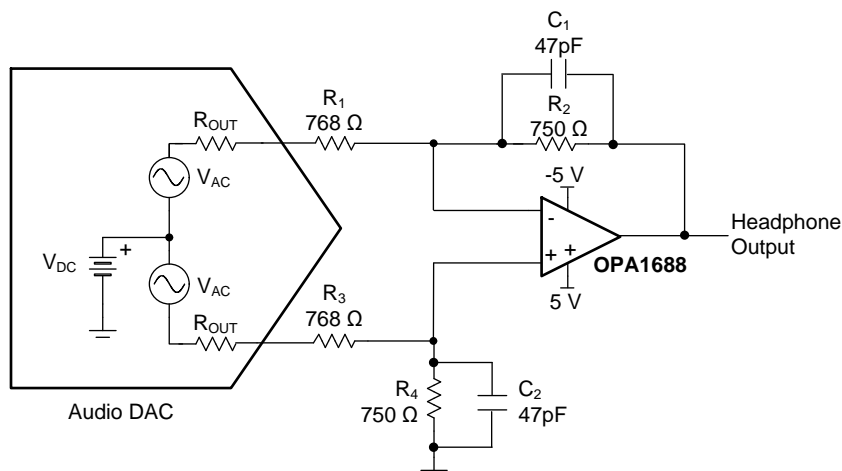

**Figure 49. Headphone Amplifier Circuit Configuration for Audio DACs that Output a Differential Voltage (Single Channel Shown)**

#### 10.2.1 Design Requirements

The design requirements are:

- Supply voltage: 10 V ( $\pm 5$  V)
- Headphone loads: 16  $\Omega$  to 600  $\Omega$
- THD+N: > 100 dB (1-kHz fundamental, 1  $V_{\text{RMS}}$  in 32  $\Omega$ , 22.4-kHz measurement bandwidth)
- Output power (before clipping): 50 mW into 32  $\Omega$

## Typical Application (continued)

### 10.2.2 Detailed Design Procedure

The OPA168x family offers an excellent combination of specifications for headphone amplifier circuits (such as low noise, low distortion, capacitive load stability, and relatively high output current). Furthermore, the low-power supply current and small package options make the OPA1688 an exceptionally good choice for headphone amplifiers in portable devices. A common headphone amplifier circuit for audio digital-to-analog converters (DACs) with differential voltage outputs is illustrated in Figure 49. This circuit converts the differential voltage output of the DAC to a single-ended, ground-referenced signal and provides the additional current necessary for low-impedance headphones. For  $R_2 = R_4$  and  $R_1 = R_3$ , the output voltage of the circuit is given by Equation 1:

$$V_{OUT} = 2 \times V_{AC} \frac{R_2}{R_1 + R_{OUT}}$$

where

- $R_{OUT}$  is the output impedance of the DAC and
  - $2 \times V_{AC}$  is the unloaded differential output voltage
- (1)

The output voltage required for headphones depends on the headphone impedance as well as the headphone efficiency. Both values can be provided by the headphone manufacturer, with headphone efficiency usually given as a sound pressure level (SPL) produced with 1 mW of input power and denoted by the Greek letter  $\eta$ . The SPL at other input power levels can be calculated from the efficiency specification using Equation 2:

$$SPL \text{ (dB)} = \eta + 10 \log\left(\frac{P_{IN}}{1 \text{ mW}}\right)$$

(2)

Note that at extremely high power levels, the accuracy of this calculation decreases as a result of secondary effects in the headphone drivers. Figure 50 allows the SPL produced by a pair of headphones of a known sensitivity to be estimated for a given input power.

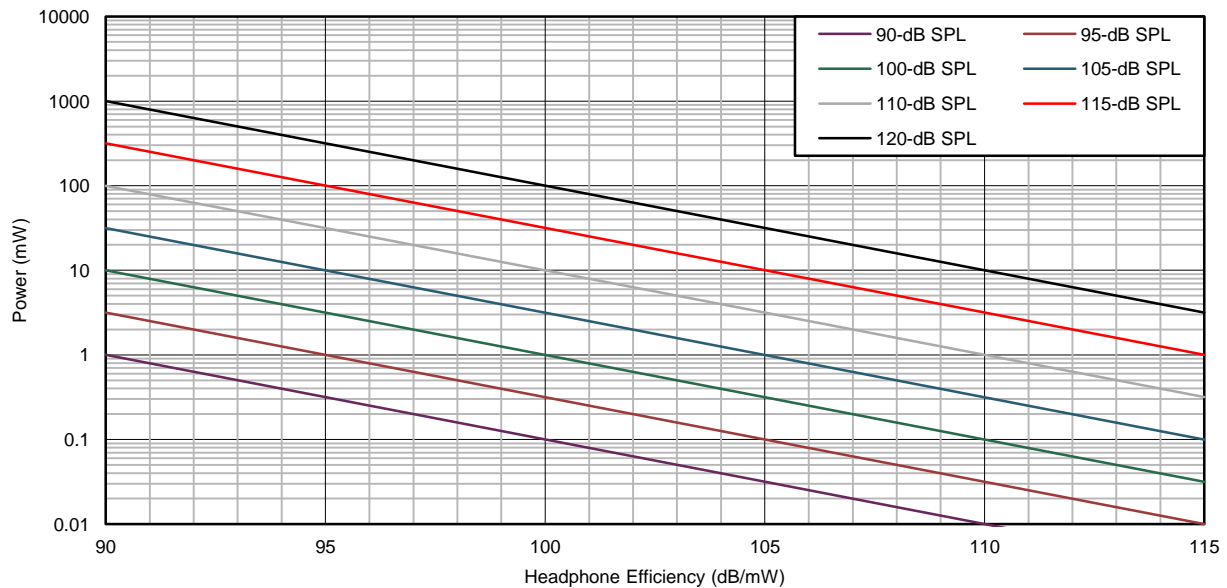

Figure 50. SPLs Produced for Various Headphone Efficiencies and Input Power Levels

## Typical Application (continued)

For example, a pair of headphones with a 95-dB/mW sensitivity given a 3-mW input signal produces a 100-dB SPL. If these headphones have a nominal impedance of 32 Ω, then the voltage and current from the headphone amplifier is as described in Equation 3 and Equation 4, respectively:

$$V = \sqrt{P_{IN} \times R_{HP}} = \sqrt{3 \text{ mW} \times 32 \Omega} = 310 \text{ mV}_{RMS} \quad (3)$$

$$I = \sqrt{\frac{P_{IN}}{R_{HP}}} = \sqrt{\frac{3 \text{ mW}}{32 \Omega}} = 9.68 \text{ mA}_{RMS} \quad (4)$$

Headphones can present a capacitive load at high frequencies that can destabilize the headphone amplifier circuit. Many headphone amplifiers use a resistor in series with the output to maintain stability; however this solution also compromises audio quality. The OPA168x family is able to maintain stability into large capacitive loads; therefore, a series output resistor is not necessary in the headphone amplifier circuit. TINA-TI™ simulations illustrate that the circuit in Figure 49 has a phase margin of approximately 50 degrees with a 400-pF load connected directly to the amplifier output.

### 10.2.3 Application Curves

The headphone amplifier circuit in Figure 49 is tested with three common headphone impedances: 16 Ω, 32 Ω, and 600 Ω. The total harmonic distortion and noise (THD+N) for increasing output voltages is given in Figure 51. This measurement is performed with a 1-kHz input signal and a measurement bandwidth of 22.4 kHz. The maximum output power and THD+N before clipping are given in Table 4. The maximum output power into low-impedance headphones is limited by the output current capabilities of the amplifier. For high-impedance headphones (600 Ω), the output voltage capabilities of the amplifier are the limiting factor. The circuit in Figure 49 is tested using ±5-V supplies that are common in many portable systems. However, using higher supply voltages increases the output power into 600-Ω headphones.

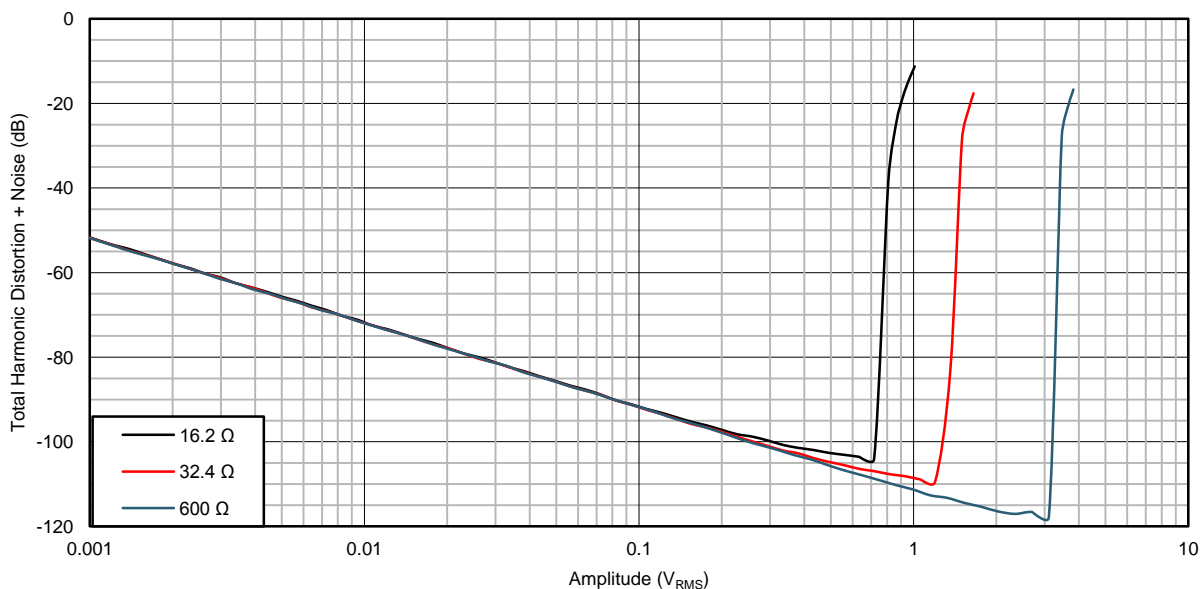

**Figure 51. THD+N for Increasing Output Voltages Into Three Load Impedances (Input Signal = 1 kHz, Measurement Bandwidth = 22.4 kHz)**

Typical Application (continued)

Table 4. Maximum Output Power and THD+N Before Clipping for Different Load Impedances

LOAD IMPEDANCE ( $\Omega$ )	MAXIMUM OUTPUT POWER BEFORE CLIPPING (mW)	THD+N AT MAXIMUM OUTPUT POWER (dB)
16	32	-104.1
32	50	-109.5
600	16	-117.8

Figure 52, Figure 53, and Figure 54 further illustrate the exceptional performance of the OPA1688 as a headphone amplifier.

Figure 52 shows the THD+N over frequency for a 500-mV<sub>RMS</sub> output signal into the same three load impedances previously tested.

Figure 53 and Figure 54 show the output spectrum of the OPA1688 at low (1 mW) and high (50 mW) output power levels into a 32- $\Omega$  load. The distortion harmonics in both cases are approximately 120 dB below the fundamental.

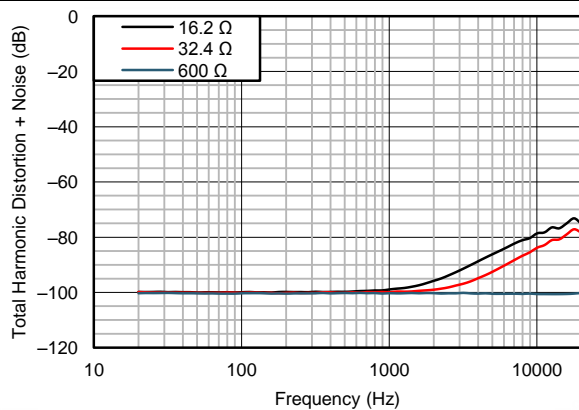

Figure 52. THD+N Measured over Frequency (90-kHz Measurement Bandwidth) for a 500-mV<sub>RMS</sub> Output Level

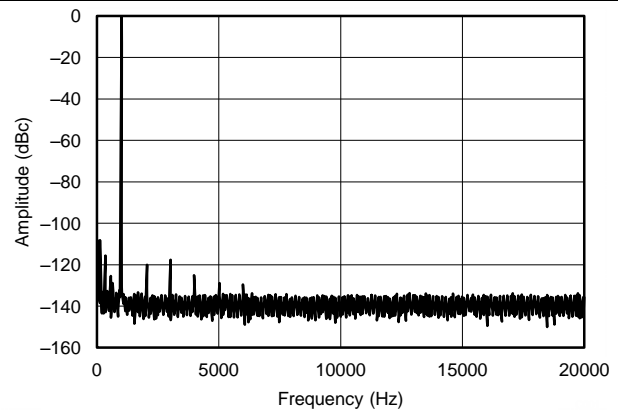

Figure 53. Output Spectrum of a 1-mW, 1-kHz Tone into a 32- $\Omega$  Load (The third harmonic is dominant at a level of -117.6 dB relative to the fundamental.)

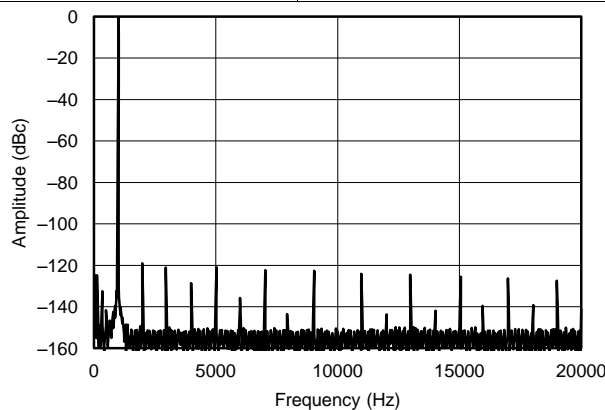

Figure 54. Output Spectrum of a 50-mW, 1-kHz Tone Into a 32- $\Omega$  Load, Immediately Below the Onset of Clipping (The highest harmonic is the second harmonic at -119 dB below the fundamental.)

## 11 Power Supply Recommendations

The OPA168x is specified for operation from 4.5 V to 36 V ( $\pm 2.25$  V to  $\pm 18$  V); many specifications apply from  $-40^{\circ}\text{C}$  to  $85^{\circ}\text{C}$ . Parameters that can exhibit significant variance with regard to operating voltage or temperature are presented in the [Typical Characteristics](#).

### CAUTION

Supply voltages larger than 40 V can permanently damage the device; see the [Absolute Maximum Ratings](#).

Place 0.1- $\mu\text{F}$  bypass capacitors close to the power-supply pins to reduce errors coupling in from noisy or high-impedance power supplies. For more detailed information on bypass capacitor placement, see the [Layout](#) section.

## 12 Layout

### 12.1 Layout Guidelines

For best operational performance of the device, use good printed circuit board (PCB) layout practices, including:

- Noise can propagate into analog circuitry through the power pins of the circuit as a whole and the op amp itself. Bypass capacitors are used to reduce the coupled noise by providing low-impedance power sources local to the analog circuitry.
  - Connect low-ESR, 0.1- $\mu\text{F}$  ceramic bypass capacitors between each supply pin and ground, placed as close to the device as possible. A single bypass capacitor from V+ to ground is applicable for single-supply applications.
- Separate grounding for analog and digital portions of circuitry is one of the simplest and most-effective methods of noise suppression. One or more layers on multilayer PCBs are usually devoted to ground planes. A ground plane helps distribute heat and reduces EMI noise pickup. Make sure to physically separate digital and analog grounds, paying attention to the flow of the ground current. For more detailed information, see [SLOA089, Circuit Board Layout Techniques](#).
- In order to reduce parasitic coupling, run the input traces as far away from the supply or output traces as possible. If these traces cannot be kept separate, crossing the sensitive trace perpendicularly is much better than in parallel with the noisy trace.
- Place the external components as close to the device as possible. As illustrated in [Figure 55](#), keeping RF and RG close to the inverting input minimizes parasitic capacitance.
- Keep the length of input traces as short as possible. Always remember that the input traces are the most sensitive part of the circuit.
- Consider a driven, low-impedance guard ring around the critical traces. A guard ring can significantly reduce leakage currents from nearby traces that are at different potentials.

## 12.2 Layout Example

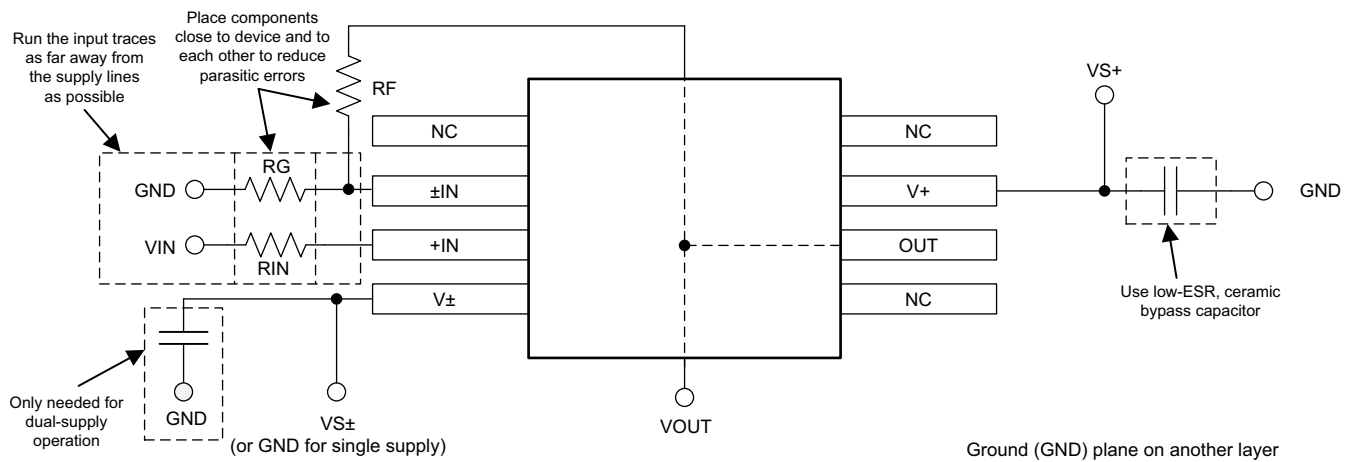
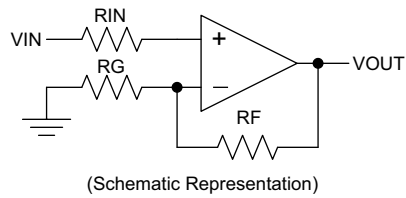

**Figure 55. Operational Amplifier Board Layout for a Noninverting Configuration**

## 13 Device and Documentation Support

### 13.1 Device Support

#### 13.1.1 Development Support

##### 13.1.1.1 TINA-TI™ (Free Software Download)

TINA™ is a simple, powerful, and easy-to-use circuit simulation program based on a SPICE engine. TINA-TI is a free, fully-functional version of the TINA software, preloaded with a library of macro models in addition to a range of both passive and active models. TINA-TI provides all the conventional dc, transient, and frequency domain analysis of SPICE, as well as additional design capabilities.

Available as a [free download](#) from the Analog eLab Design Center, TINA-TI offers extensive post-processing capability that allows users to format results in a variety of ways. Virtual instruments offer the ability to select input waveforms and probe circuit nodes, voltages, and waveforms, creating a dynamic quick-start tool.

#### NOTE

These files require that either the TINA software (from DesignSoft™) or TINA-TI software be installed. Download the free TINA-TI software from the [TINA-TI folder](#).

### 13.2 Documentation Support

#### 13.2.1 Related Documentation

[SBOA015 \(AB-028\)](#) — *Feedback Plots Define Op Amp AC Performance*

[SBOA128](#) — *EMI Rejection Ratio of Operational Amplifiers*

[SLOA089](#) — *Circuit Board Layout Techniques*

[SLOD006](#) — *Op Amps for Everyone*

[TIPD128](#) — *Capacitive Load Drive Solution using an Isolation Resistor*

### 13.3 Related Links

The table below lists quick access links. Categories include technical documents, support and community resources, tools and software, and quick access to sample or buy.

**Table 5. Related Links**

PARTS	PRODUCT FOLDER	SAMPLE & BUY	TECHNICAL DOCUMENTS	TOOLS & SOFTWARE	SUPPORT & COMMUNITY
OPA1688	<a href="#">Click here</a>	<a href="#">Click here</a>	<a href="#">Click here</a>	<a href="#">Click here</a>	<a href="#">Click here</a>
OPA1689	<a href="#">Click here</a>	<a href="#">Click here</a>	<a href="#">Click here</a>	<a href="#">Click here</a>	<a href="#">Click here</a>

### 13.4 Community Resources

The following links connect to TI community resources. Linked contents are provided "AS IS" by the respective contributors. They do not constitute TI specifications and do not necessarily reflect TI's views; see TI's [Terms of Use](#).

**TI E2E™ Online Community** *TI's Engineer-to-Engineer (E2E) Community*. Created to foster collaboration among engineers. At [e2e.ti.com](http://e2e.ti.com), you can ask questions, share knowledge, explore ideas and help solve problems with fellow engineers.

**Design Support** *TI's Design Support* Quickly find helpful E2E forums along with design support tools and contact information for technical support.

### 13.5 Trademarks

E2E is a trademark of Texas Instruments.

SoundPlus is a trademark of Texas Instruments, Inc.

TINA-TI is a trademark of Texas Instruments, Inc and DesignSoft, Inc.

Blu-Ray is a trademark of Blu-ray Disc Association (BDA).

Bluetooth is a registered trademark of Bluetooth SIG, Inc.

TINA, DesignSoft are trademarks of DesignSoft, Inc.

All other trademarks are the property of their respective owners.

### 13.6 Electrostatic Discharge Caution



This integrated circuit can be damaged by ESD. Texas Instruments recommends that all integrated circuits be handled with appropriate precautions. Failure to observe proper handling and installation procedures can cause damage.

ESD damage can range from subtle performance degradation to complete device failure. Precision integrated circuits may be more susceptible to damage because very small parametric changes could cause the device not to meet its published specifications.

### 13.7 Glossary

[SLYZ022](#) — *TI Glossary*.

This glossary lists and explains terms, acronyms, and definitions.

## 14 Mechanical, Packaging, and Orderable Information

The following pages include mechanical, packaging, and orderable information. This information is the most current data available for the designated devices. This data is subject to change without notice and revision of this document. For browser-based versions of this data sheet, refer to the left-hand navigation.

## PACKAGING INFORMATION

Orderable Device	Status (1)	Package Type	Package Drawing	Pins	Package Qty	Eco Plan (2)	Lead/Ball Finish (6)	MSL Peak Temp (3)	Op Temp (°C)	Device Marking (4/5)	Samples
OPA1688ID	ACTIVE	SOIC	D	8	75	Green (RoHS & no Sb/Br)	CU NIPDAU	Level-2-260C-1 YEAR	-40 to 85	O1688A	<a href="#">Samples</a>
OPA1688IDR	ACTIVE	SOIC	D	8	2500	Green (RoHS & no Sb/Br)	CU NIPDAU	Level-2-260C-1 YEAR	-40 to 85	O1688A	<a href="#">Samples</a>
OPA1688IDRGR	ACTIVE	SON	DRG	8	3000	Green (RoHS & no Sb/Br)	CU NIPDAU	Level-2-260C-1 YEAR	-40 to 85	OP1688	<a href="#">Samples</a>
OPA1688IDRGT	ACTIVE	SON	DRG	8	250	Green (RoHS & no Sb/Br)	CU NIPDAU	Level-2-260C-1 YEAR	-40 to 85	OP1688	<a href="#">Samples</a>

(1) The marketing status values are defined as follows:

**ACTIVE:** Product device recommended for new designs.

**LIFEBUY:** TI has announced that the device will be discontinued, and a lifetime-buy period is in effect.

**NRND:** Not recommended for new designs. Device is in production to support existing customers, but TI does not recommend using this part in a new design.

**PREVIEW:** Device has been announced but is not in production. Samples may or may not be available.

**OBSELETE:** TI has discontinued the production of the device.

(2) Eco Plan - The planned eco-friendly classification: Pb-Free (RoHS), Pb-Free (RoHS Exempt), or Green (RoHS & no Sb/Br) - please check <http://www.ti.com/productcontent> for the latest availability information and additional product content details.

**TBD:** The Pb-Free/Green conversion plan has not been defined.

**Pb-Free (RoHS):** TI's terms "Lead-Free" or "Pb-Free" mean semiconductor products that are compatible with the current RoHS requirements for all 6 substances, including the requirement that lead not exceed 0.1% by weight in homogeneous materials. Where designed to be soldered at high temperatures, TI Pb-Free products are suitable for use in specified lead-free processes.

**Pb-Free (RoHS Exempt):** This component has a RoHS exemption for either 1) lead-based flip-chip solder bumps used between the die and package, or 2) lead-based die adhesive used between the die and leadframe. The component is otherwise considered Pb-Free (RoHS compatible) as defined above.

**Green (RoHS & no Sb/Br):** TI defines "Green" to mean Pb-Free (RoHS compatible), and free of Bromine (Br) and Antimony (Sb) based flame retardants (Br or Sb do not exceed 0.1% by weight in homogeneous material)

(3) MSL, Peak Temp. - The Moisture Sensitivity Level rating according to the JEDEC industry standard classifications, and peak solder temperature.

(4) There may be additional marking, which relates to the logo, the lot trace code information, or the environmental category on the device.

(5) Multiple Device Markings will be inside parentheses. Only one Device Marking contained in parentheses and separated by a "~" will appear on a device. If a line is indented then it is a continuation of the previous line and the two combined represent the entire Device Marking for that device.

(6) Lead/Ball Finish - Orderable Devices may have multiple material finish options. Finish options are separated by a vertical ruled line. Lead/Ball Finish values may wrap to two lines if the finish value exceeds the maximum column width.

**Important Information and Disclaimer:** The information provided on this page represents TI's knowledge and belief as of the date that it is provided. TI bases its knowledge and belief on information provided by third parties, and makes no representation or warranty as to the accuracy of such information. Efforts are underway to better integrate information from third parties. TI has taken and continues to take reasonable steps to provide representative and accurate information but may not have conducted destructive testing or chemical analysis on incoming materials and chemicals. TI and TI suppliers consider certain information to be proprietary, and thus CAS numbers and other limited information may not be available for release.

In no event shall TI's liability arising out of such information exceed the total purchase price of the TI part(s) at issue in this document sold by TI to Customer on an annual basis.

DRG (S-PWSON-N8)

PLASTIC SMALL OUTLINE NO-LEAD

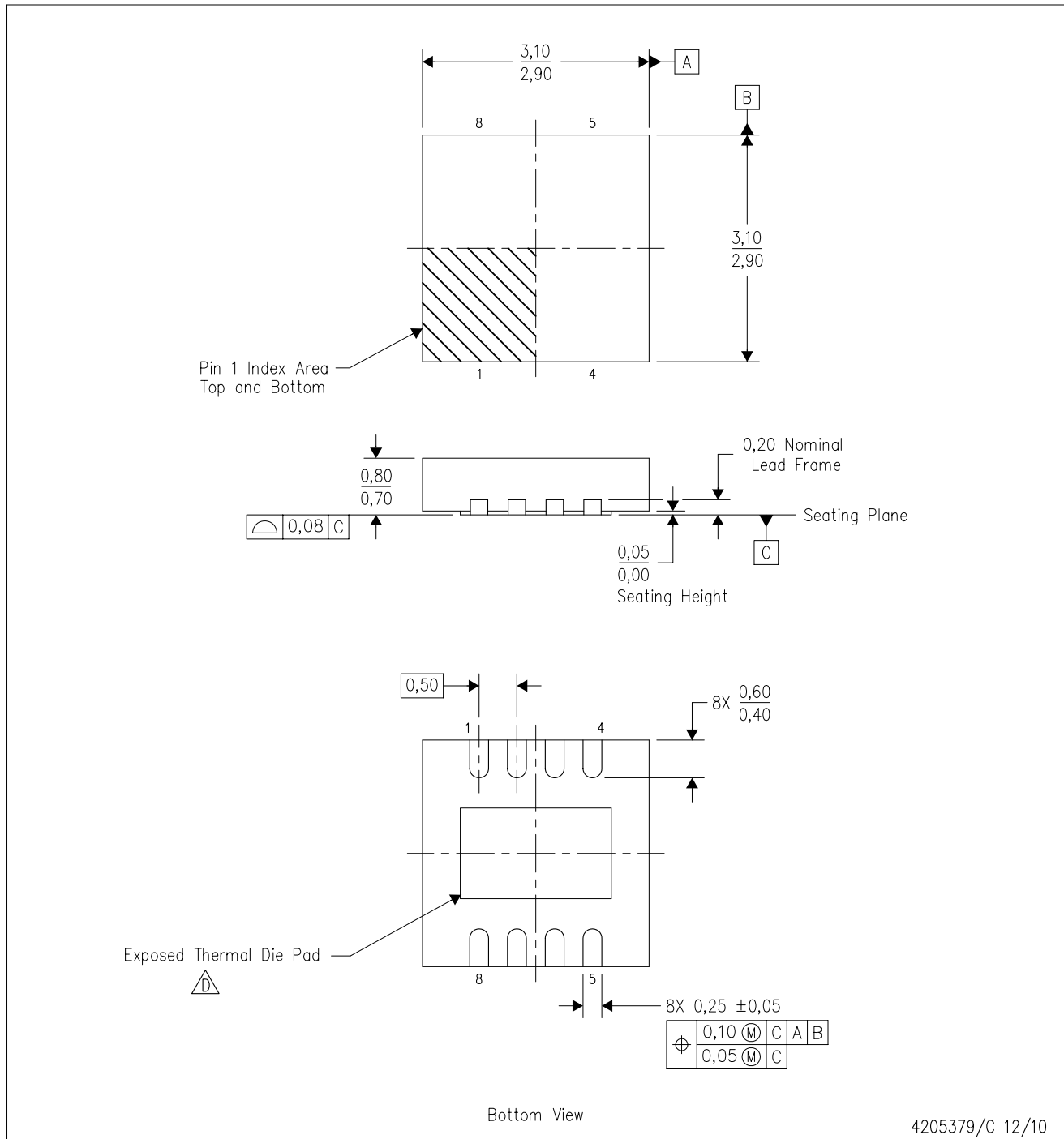

- NOTES:
- A. All linear dimensions are in millimeters. Dimensioning and tolerancing per ASME Y14.5M-1994.
  - B. This drawing is subject to change without notice.
  - C. SON (Small Outline No-Lead) package configuration.
  - D. The package thermal pad must be soldered to the board for thermal and mechanical performance. See the Product Data Sheet for details regarding the exposed thermal pad dimensions.
  - E. JEDEC MO-229 package registration pending.

# THERMAL PAD MECHANICAL DATA

DRG (S-PWSON-N8)

PLASTIC SMALL OUTLINE NO-LEAD

## THERMAL INFORMATION

This package incorporates an exposed thermal pad that is designed to be attached directly to an external heatsink. The thermal pad must be soldered directly to the printed circuit board (PCB). After soldering, the PCB can be used as a heatsink. In addition, through the use of thermal vias, the thermal pad can be attached directly to the appropriate copper plane shown in the electrical schematic for the device, or alternatively, can be attached to a special heatsink structure designed into the PCB. This design optimizes the heat transfer from the integrated circuit (IC).

For information on the Quad Flatpack No-Lead (QFN) package and its advantages, refer to Application Report, QFN/SON PCB Attachment, Texas Instruments Literature No. SLUA271. This document is available at [www.ti.com](http://www.ti.com).

The exposed thermal pad dimensions for this package are shown in the following illustration.

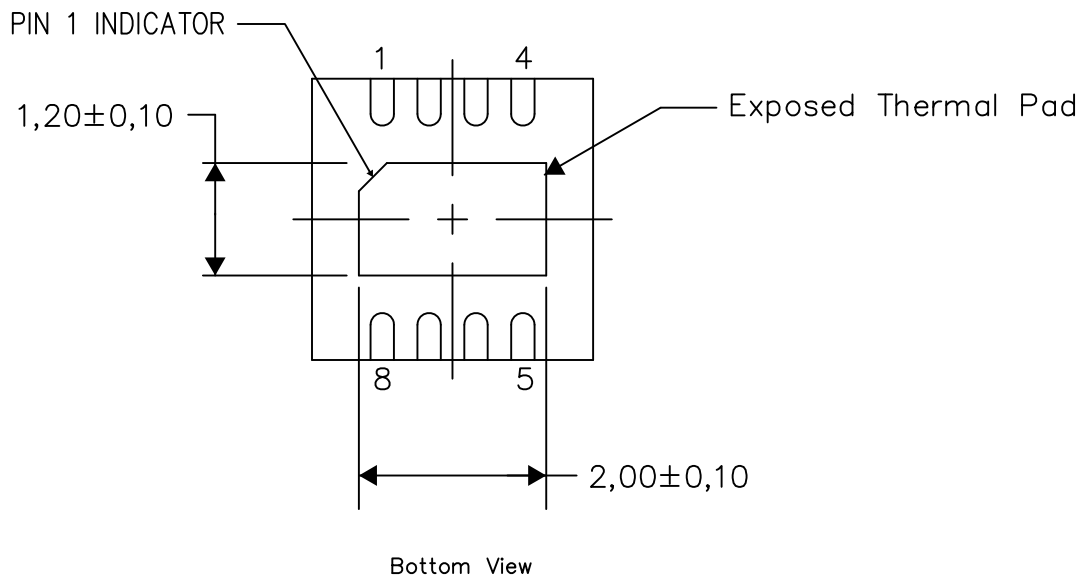

Exposed Thermal Pad Dimensions

4206881-2/1 03/15

NOTE: All linear dimensions are in millimeters

DRG (S-PWSON-N8)

PLASTIC SMALL OUTLINE NO-LEAD

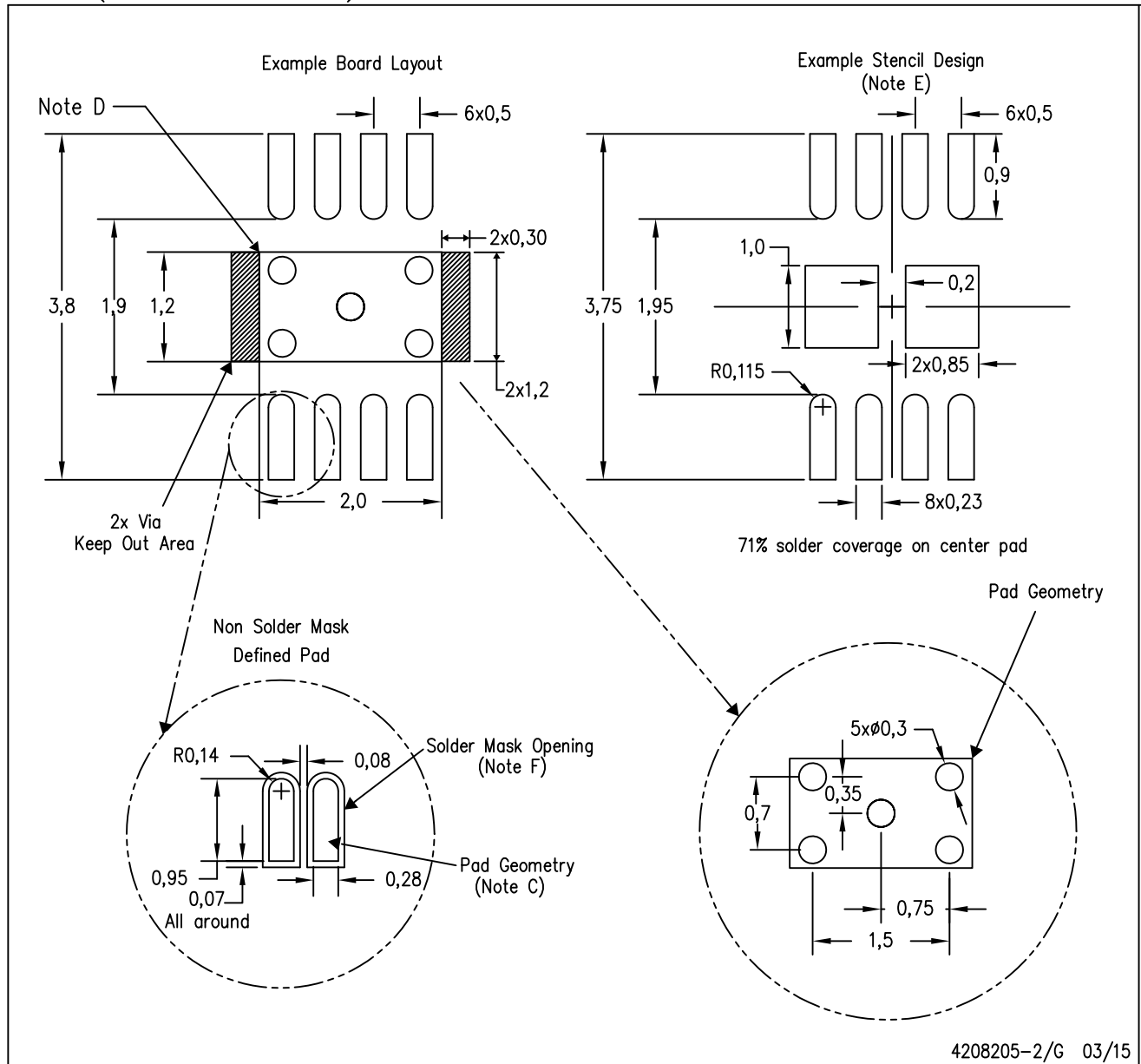

4208205-2/G 03/15

- NOTES:
- All linear dimensions are in millimeters.
  - This drawing is subject to change without notice.
  - Publication IPC-SM-782 is recommended for alternate designs.
  - This package is designed to be soldered to a thermal pad on the board. Refer to Application Note, Quad Flat-Pack Packages, Texas Instruments Literature No. SLUA271, and also the Product Data Sheets for specific thermal information, via requirements, and recommended board layout. These documents are available at [www.ti.com](http://www.ti.com) <<http://www.ti.com>>.
  - Laser cutting apertures with trapezoidal walls and also rounding corners will offer better paste release. Customers should contact their board assembly site for stencil design recommendations. Refer to IPC 7525 for stencil design considerations.
  - Customers should contact their board fabrication site for minimum solder mask web tolerances between signal pads.



## IMPORTANT NOTICE

Texas Instruments Incorporated and its subsidiaries (TI) reserve the right to make corrections, enhancements, improvements and other changes to its semiconductor products and services per JESD46, latest issue, and to discontinue any product or service per JESD48, latest issue. Buyers should obtain the latest relevant information before placing orders and should verify that such information is current and complete. All semiconductor products (also referred to herein as "components") are sold subject to TI's terms and conditions of sale supplied at the time of order acknowledgment.

TI warrants performance of its components to the specifications applicable at the time of sale, in accordance with the warranty in TI's terms and conditions of sale of semiconductor products. Testing and other quality control techniques are used to the extent TI deems necessary to support this warranty. Except where mandated by applicable law, testing of all parameters of each component is not necessarily performed.

TI assumes no liability for applications assistance or the design of Buyers' products. Buyers are responsible for their products and applications using TI components. To minimize the risks associated with Buyers' products and applications, Buyers should provide adequate design and operating safeguards.

TI does not warrant or represent that any license, either express or implied, is granted under any patent right, copyright, mask work right, or other intellectual property right relating to any combination, machine, or process in which TI components or services are used. Information published by TI regarding third-party products or services does not constitute a license to use such products or services or a warranty or endorsement thereof. Use of such information may require a license from a third party under the patents or other intellectual property of the third party, or a license from TI under the patents or other intellectual property of TI.

Reproduction of significant portions of TI information in TI data books or data sheets is permissible only if reproduction is without alteration and is accompanied by all associated warranties, conditions, limitations, and notices. TI is not responsible or liable for such altered documentation. Information of third parties may be subject to additional restrictions.

Resale of TI components or services with statements different from or beyond the parameters stated by TI for that component or service voids all express and any implied warranties for the associated TI component or service and is an unfair and deceptive business practice. TI is not responsible or liable for any such statements.

Buyer acknowledges and agrees that it is solely responsible for compliance with all legal, regulatory and safety-related requirements concerning its products, and any use of TI components in its applications, notwithstanding any applications-related information or support that may be provided by TI. Buyer represents and agrees that it has all the necessary expertise to create and implement safeguards which anticipate dangerous consequences of failures, monitor failures and their consequences, lessen the likelihood of failures that might cause harm and take appropriate remedial actions. Buyer will fully indemnify TI and its representatives against any damages arising out of the use of any TI components in safety-critical applications.

In some cases, TI components may be promoted specifically to facilitate safety-related applications. With such components, TI's goal is to help enable customers to design and create their own end-product solutions that meet applicable functional safety standards and requirements. Nonetheless, such components are subject to these terms.

No TI components are authorized for use in FDA Class III (or similar life-critical medical equipment) unless authorized officers of the parties have executed a special agreement specifically governing such use.

Only those TI components which TI has specifically designated as military grade or "enhanced plastic" are designed and intended for use in military/aerospace applications or environments. Buyer acknowledges and agrees that any military or aerospace use of TI components which have **not** been so designated is solely at the Buyer's risk, and that Buyer is solely responsible for compliance with all legal and regulatory requirements in connection with such use.

TI has specifically designated certain components as meeting ISO/TS16949 requirements, mainly for automotive use. In any case of use of non-designated products, TI will not be responsible for any failure to meet ISO/TS16949.

### Products

Audio	<a href="http://www.ti.com/audio">www.ti.com/audio</a>
Amplifiers	<a href="http://amplifier.ti.com">amplifier.ti.com</a>
Data Converters	<a href="http://dataconverter.ti.com">dataconverter.ti.com</a>
DLP® Products	<a href="http://www.dlp.com">www.dlp.com</a>
DSP	<a href="http://dsp.ti.com">dsp.ti.com</a>
Clocks and Timers	<a href="http://www.ti.com/clocks">www.ti.com/clocks</a>
Interface	<a href="http://interface.ti.com">interface.ti.com</a>
Logic	<a href="http://logic.ti.com">logic.ti.com</a>
Power Mgmt	<a href="http://power.ti.com">power.ti.com</a>
Microcontrollers	<a href="http://microcontroller.ti.com">microcontroller.ti.com</a>
RFID	<a href="http://www.ti-rfid.com">www.ti-rfid.com</a>
OMAP Applications Processors	<a href="http://www.ti.com/omap">www.ti.com/omap</a>
Wireless Connectivity	<a href="http://www.ti.com/wirelessconnectivity">www.ti.com/wirelessconnectivity</a>

### Applications

Automotive and Transportation	<a href="http://www.ti.com/automotive">www.ti.com/automotive</a>
Communications and Telecom	<a href="http://www.ti.com/communications">www.ti.com/communications</a>
Computers and Peripherals	<a href="http://www.ti.com/computers">www.ti.com/computers</a>
Consumer Electronics	<a href="http://www.ti.com/consumer-apps">www.ti.com/consumer-apps</a>
Energy and Lighting	<a href="http://www.ti.com/energy">www.ti.com/energy</a>
Industrial	<a href="http://www.ti.com/industrial">www.ti.com/industrial</a>
Medical	<a href="http://www.ti.com/medical">www.ti.com/medical</a>
Security	<a href="http://www.ti.com/security">www.ti.com/security</a>
Space, Avionics and Defense	<a href="http://www.ti.com/space-avionics-defense">www.ti.com/space-avionics-defense</a>
Video and Imaging	<a href="http://www.ti.com/video">www.ti.com/video</a>

### TI E2E Community

[e2e.ti.com](http://e2e.ti.com)